

Hereby, Thousandshores Deutschland GmbH declares that the radio equipment type Portable Wireless Speaker BTS35 is in compliance with Directive 2014/53/EU. The full text of the EU declaration conformity is available at the following internet address:
<http://files.tribit.com/e35-1368n-01-eu-doc.pdf>

Hiermit erklärt Thousandshores Deutschland GmbH, dass der Funkanlagentyp Portable Wireless Speaker BTS35 der Richtlinie 2014/53/EU entspricht. Der vollständige Text der EU-Konformitätserklärung ist unter der folgenden Internetadresse verfügbar:
<http://files.tribit.com/e35-1368n-01-de-doc.pdf>

Learn more about the UK Declaration of Conformity, Please click below link to download. <http://files.tribit.com/e35-1368n-01-uk-doc.pdf>

Tribit XSound Mega

Portable Wireless Speaker

BTS35



English User Manual

Benutzerhandbuch | Guide Utilisateur | Manual de Usuario

Manuale Utente | 取扱説明書 | 用户手册

Contents

English User Manual	01
---------------------	----

Benutzerhandbuch	15
------------------	----

Guide Utilisateur	28
-------------------	----

Manual de Usuario	41
-------------------	----

Manuale Utente	54
----------------	----

取扱説明書	67
-------	----

用户手册	79
------	----

Safety Precautions

- * Avoid dropping.
- * Do not disassemble or repair the speaker.
- * Avoid extreme temperatures.
- * Do not use the device outdoors during thunderstorms.
- * Do not use any corrosive cleanser/oil to clean.

Specification

Bluetooth version: 5.0

Support: A2DP, AVRCP, HFP, HSP

Output power: 30W

Frequency response: 60Hz~20KHz

Frequency band: 2.402GHz~2.480GHz

Maximum transmission power: $\leq 6\text{dBm}$

Battery: 7.3V, 4000mAh, 29.2Wh

Music play time: Up to 20hours (varies volume level and music files)

Charge time: 4H

Input: DC 5V/2A

Waterproof: IPX7

Dimensions: 250mm x 87mm x 80mm

Weight: 1020g

What's in the Box



XSound Mega



User Manual



Strap



USB-C charging cable



Audio Line

Overview

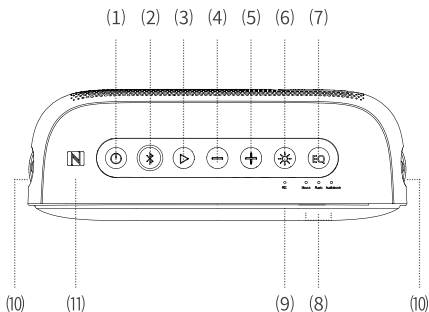

- | | |
|---------------------------------|-----------------------|
| 1. Power Button / Indicator | 7. EQ Mode Button |
| 2. Bluetooth Button / Indicator | 8. EQ Mode Indicators |
| 3. MFB | 9. MIC |
| 4. Volume - | 10. Hanging holes |
| 5. Volume + | 11. NFC |
| 6. Light Adjustment Button | |

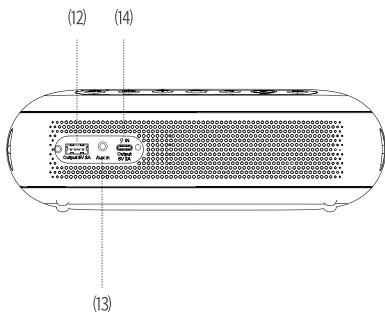

- 12. USB-A charging port (output)
- 13. AUX-IN port
- 14. USB-C charging port (input/output)

Connections

Speaker charge to other devices

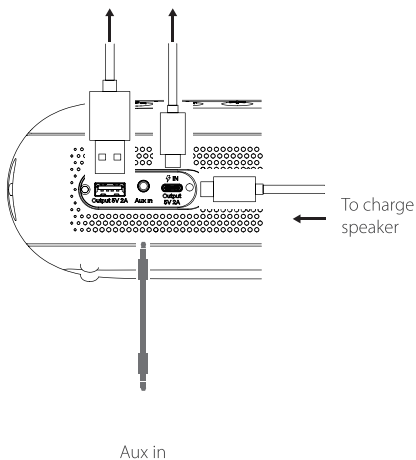

Bluetooth Pairing

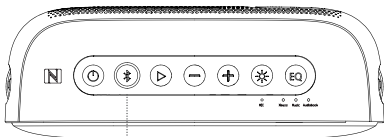

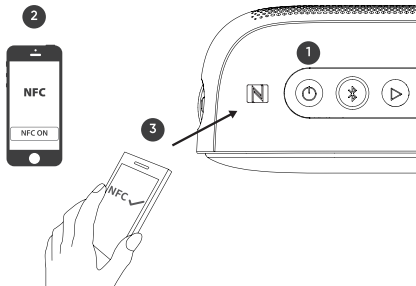

Connections



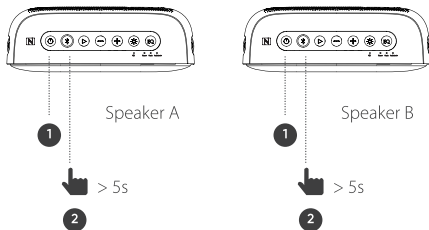

1. Make sure the speaker is on.
2. Open NFC in your phone.
3. The NFC area on the phone needs to be close to the NFC area on the speaker. The phone will automatically recognize the speaker and request pairing. Click "agree" to complete pairing.





Broadcast Mode







1. Make sure both speakers are on, and connect speaker A to device;
2. Press the Bluetooth button both speakers for 5s to enter Broadcast pairing mode, and speaker B will connect to speaker A automatically, the Broadcast Mode is on.
3. if you want to connect multiple speakers to the group, press the  button 5S, the speaker will connect to speaker A automatically.

Button Controls

Function	Button	Operation
Power ON / OFF		Press the button to turn on / off the speaker
Pair Bluetooth Device		Press the button to manually enter bluetooth pairing mode
Broadcast mode		Press and hold the button 5s to enter Broadcast mode
Disconnect Broadcast mode		Press and hold the button 5s to disconnect Broadcast mode
Play / Pause		Press once the button
Next track		Double press the button
Previous track		Press the button for 3 times

Function	Button	Operation
Voice dial function		Press and hold the button for 2s to activate (your device must support this function)
Answer/end the incoming call		Press once the button
Reject an incoming call		Press and hold the button for 2s
Volume Down		Press the button to decrease the volume level
Volume Up		Press the button to increase the volume level
Light adjustment		Press the button to switch or turn off the light
EQ mode		Press the button to switch Music mode, Bass mode and Audiobook mode

Indicators

Indicator	Light	Status
Power indicator	White indicator keep sturdily on	Power on
	Red indicator flashes quickly	Battery low
	Red indicator keep sturdily on	Charging (Red indicator will power off when battery full)
Bluetooth indicator	Blue indicator  flashes quickly	Bluetooth pairing mode
	Blue indicator  flashes slowly	Bluetooth reconnecting
	Blue indicator  keep sturdily on	Connected
	White indicator  flashes quickly	Broadcast pairing mode

Indicator	Light	Status
EQ indicators	Xbass indicator keep sturdily on	Bass mode is on
	Music indicator keep sturdily on	Music mode is on
	Audiobook indicator keep sturdily on	Audiobook mode is on

Reset

If this speaker has any problem, you can try to press and hold "Volume +" and "Volume -" buttons simultaneously for 5s to reset this speaker and remove the old pairing in your Bluetooth device, and then pair again.

Customer Service

- * 18-month limited warranty
- * For FAQs and more information, please visit:
Email: support@tribit.com

FCC Statement

Changes or modifications not expressly approved by the party responsible for compliance could void the user's authority to operate the equipment.

This equipment has been tested and found to comply with the limits for a Class B digital device, pursuant to Part 15 of the FCC Rules. These limits are designed to provide reasonable protection against harmful interference in a residential installation. This equipment generates uses and can radiate radio frequency energy and, if not installed and used in accordance with the instructions, may cause harmful interference to radio communications. However, there is no guarantee that interference will not occur in a particular installation. If this equipment does cause harmful interference to radio or television reception, which can be determined by turning the equipment off and on, the user is encouraged to try to correct the interference by one or more of the following measures:

- Reorient or relocate the receiving antenna.
- Increase the separation between the equipment and receiver.
- Connect the equipment into an outlet on a circuit different from that to which the receiver is connected.
- Consult the dealer or an experienced radio/TV technician for help

This device complies with part 15 of the FCC rules. Operation is subject to the following two conditions (1) this device may not cause harmful interference, and (2) this device must accept any interference received, including interference that may cause undesired operation.

IC Caution

This device complies with Industry Canada licence-exempt RSS standard(s).

Operation is subject to the following two conditions: (1) This device may not cause interference, and (2) This device must accept any interference, including interference that may cause undesired operation of the device.

Le présent appareil est conforme aux CNR d'Industrie Canada applicables aux appareils radio exempts de licence. L'exploitation est autorisée aux deux conditions suivantes: (1) l'appareil ne doit pas produire de brouillage, et (2) l'utilisateur de l'appareil doit accepter tout brouillage radioélectrique subi, même si le brouillage est susceptible d'en compromettre le fonctionnement.

Sicherheitshinweise

- * Fallvermeidung.
- * Entfernen oder reparieren Sie die Lautsprecher nicht.
- * Vermeidung der extremen Temperaturen.
- * Verwenden Sie das Gerät bei Gewitterwetter nicht im Freien.
- * Verwenden Sie keine korrosiven Reinigungsmittel / Öle zur Reinigung.

Spezifikation

Bluetooth Version: 5.0

Kompatibilität: A2DP, AVRCP, HFP, HSP

Ausgangsleistung: 30W

Frequenzgang: 60Hz~20KHz

Begrenzung des Bandes: 2.402GHz~2.480GHz

Maximale Übertragungsleistung: $\leq 6\text{dBm}$

Batterie: 7.3V, 4000mAh, 29.2Wh

Spielzeit der Musik: Bis zu 20 Stunden (Verschiedene Lautstärken und Musikdateien)

Ladezeit: 4H

Eingang: DC 5V/2A

Wasserdicht: IPX7

Dimension: 250mm x 87mm x 80mm

Gewicht: 1020g

Lieferumfang



XSound Mega



Benutzerhandbuch



Gurt



USB-C Ladekabel



Audiokabel

Overview

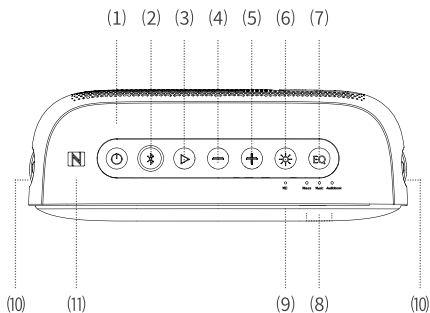

- | | |
|-----------------------------|----------------------|
| 1. Netzschalter Anzeiger | 7. EQ Modus Taste |
| 2. Bluetooth-Taste Anzeiger | 8. EQ Modus Anzeiger |
| 3. MFB | 9. Mikrophon |
| 4. Volume - | 10. Hängende Löcher |
| 5. Volume + | 11. NFC |
| 6. Lichteinstellungstaste | |

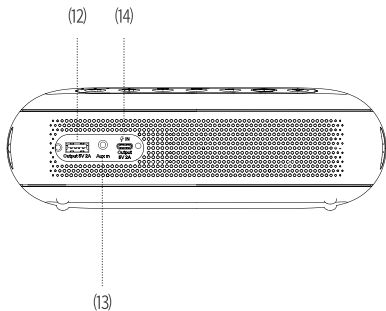

- 12. USB-A Ladeanschluss (Output)
- 13. AUX-IN-Anschluss
- 14. USB-C Ladeanschluss (Input / Output)

Verbindungen

Der Lautsprecher lädt andere Geräte

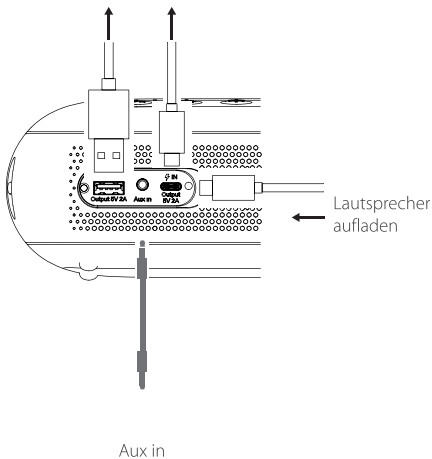

Bluetooth-Kopplung

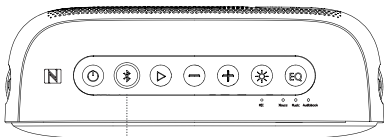

1



3

NFC Verbindung

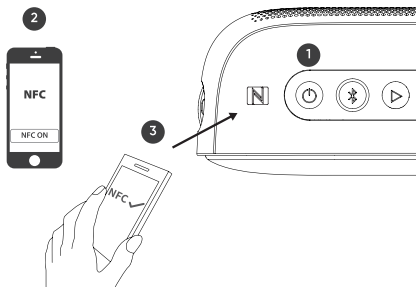



1. Stellen Sie sicher, dass der Lautsprecher eingeschaltet ist
2. Schalten Sie NFC auf Ihrem Telefon ein.
3. Der NFC-Bereich am Telefon muss sich in der Nähe des NFC-Bereichs auf dem Lautsprecher befinden. Das Telefon erkennt automatisch den Lautsprecher und fordert die Kopplung an. Klicken Sie auf "Zustimmen", um die Kopplung abzuschließen.

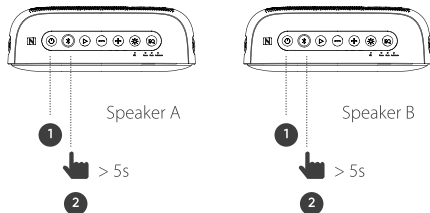



Broadcast Modus



1. Stellen Sie sicher, dass beide Lautsprecher eingeschaltet sind und dass Lautsprecher A zuerst mit dem Gerät verbunden ist.;
2. Zur gleichen Zeit drücken Sie die Bluetooth-Taste 5s der beiden Lautsprecher, um es in den Broadcast-Kopplungs-Modus zu machen. Lautsprecher B wird automatisch mit Lautsprecher A zusammen, um den Broadcast-Modus abzuschließen.
3. Wenn Sie mehrere Lautsprecher mit einer Gruppe verbinden möchten, drücken Sie die Bluetooth-Taste für 5 Sekunden, und die Lautsprecher werden automatisch mit Lautsprecher A verbunden.

Tastensteuerung

Funktion	Taste	Operation
Ein / AUS		Drücken Sie die Netzschalter kurz, um den Lautsprecher ein- und auszuschalten
Bluetooth-Kopplung		Drücken Sie die Taste kurz, um in den Bluetooth-Kopplungsmodus zu wechseln
Broadcast Modus		Halten Sie die Taste 5s, um in den Broadcast-Modus zu wechseln
Beenden des Broadcast-Modus		Halten Sie die Taste 5s eines der beiden Lautsprecher, um den aktuellen Broadcast-Modus zu beenden.
Spiel / Pause		Drücken Sie einmal die Taste.

Funktion	Taste	Operation
Nächster Titel		Doppelklicken Sie auf die MFB-Taste
Vorheriger Titel		Drücken Sie die Taste dreimal.
Sprachwahlfunktion		Halten Sie die Taste für 2 Sekunden gedrückt. (Ihr Gerät muss diese Funktion unterstützen)
Telefon beantworten / beenden		Drücken Sie einmal die Taste.
Ablehnen des Anrufs		Halten Sie die Taste für 2 Sekunden gedrückt.
Lautstärke senken		Drücken Sie die Taste, um die Lautstärke zu senken.
Lautstärke erhöhen		Drücken Sie die Taste, um die Lautstärke zu erhöhen.
Lichteinstellung		Drücken Sie die Taste, um das Licht ein- oder auszuschalten

Funktion	Taste	Operation
EQ Modus	EQ	Drücken Sie die Taste, um den Musikmodus, den Bassmodus und den Hörbuchmodus zu wechseln

Indicators

Anzeiger	Licht	Zustand
Leistung Anzeiger	Der weiße Anzeiger ist immer eingeschaltet	Einschalten
	Der rote Anzeiger blinkt schnell	Geringe Leistung
	Der rote Anzeiger ist immer eingeschaltet	Ladezustand(Wenn der Akku vollständig aufgeladen ist, erlischt das rote Licht)

Anzeiger	Licht	Zustand
Bluetooth Anzeiger	Blau Anzeiger  blinken schnell	Bluetooth Kopplung Modus
	Blau Anzeiger  blinken langsam	Bluetooth Verbindung
	Blau Anzeiger  einschalten bleiben	Verbunden
	Weiß Anzeiger  blinken schnell	Broadcast Kopplung Modus
EQ Anzeiger	Der Xbass Anzeiger leuchtet stetig	Bass Modus ist eingeschaltet
	Der Musik Anzeiger leuchtet stetig	Musik Modus ist eingeschaltet
	Hörbuchmodus Anzeiger leuchtet stetig	Hörbuchmodus ist eingeschaltet

Zurücksetzen

Wenn ein Problem mit diesem Lautsprecher auftritt, können Sie versuchen, die Lautstärke+ und Lautstärke- 5 Sekunden gleichzeitig gedrückt zu halten, um den Lautsprecher zurückzusetzen und die alte Kopplung von Ihrem Bluetooth-Gerät zu entfernen, und dann erneut zu koppeln.

Kundendienst

- * 18 Monate eingeschränkte Garantie
- * Für FAQ und mehr Informationen besuchen Sie bitte:
Email: support@tribit.com

Mesures de sécurité

- * Évitez de le laisser tomber.
- * Ne démontez pas et ne réparez pas le haut-parleur.
- * Évitez les températures extrêmes.
- * N'utilisez pas l'appareil à l'extérieur pendant les orages.
N'utilisez pas de nettoyeurs/huiles corrosifs pour le
- * nettoyage.

Caractéristiques

Version Bluetooth : 5.0

Support : A2DP, AVRCP, HFP, HSP

Puissance de sortie : 30W

Réponse en fréquence : 60Hz ~ 20KHz

Gamme de fréquences : 2.402GHz~2.480GHz

Puissance de transmission maximale : ≤ 6 dBm

Batterie : 7.3V, 4000mAh, 29.2Wh

Durée de lecture de la musique : jusqu'à 20 heures (varie en fonction du volume et des fichiers musicaux)

Temps de charge : 4H à

Entré: DC 5V/2A

Étanchéité : IPX7

Dimensions : 250mm x 87mm x 80mm

Poids : 1020g

Ce qu'il y a dans le colis



XSound Mega



Manuel d'utilisation



Sangle



Câble de chargement USB-C



Câble audio

Aperçu

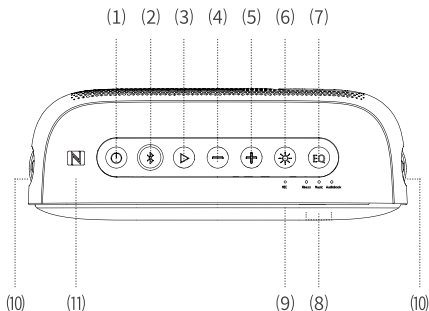

1. Touche d'alimentation
2. Touche Bluetooth
3. MFB
4. Volume -
5. Volume +
6. Touche de réglage de la lumière

7. Touche de mode égaliseur (EQ)
8. Voyants du mode égaliseur (EQ)
9. MICRO
10. Trous d'accrochage
11. NFC

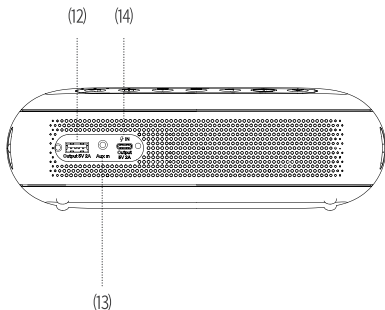

- 12. Port de recharge USB-A (sortie)
- 13. Port d'entrée audio (AUX-IN)
- 14. Port de recharge USB-C (entrée / sortie)

Liens

Chargement du haut-parleur sur d'autres appareils

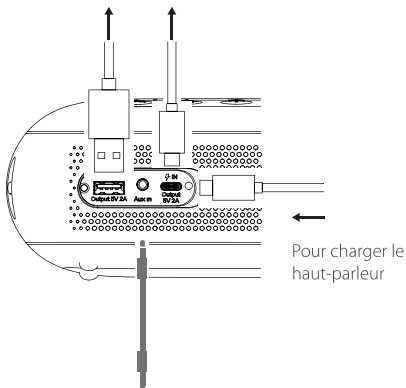

Entrée audio

Connexion Bluetooth

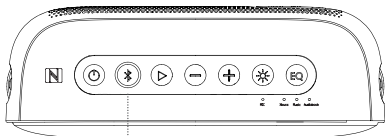

1



3

Connexion NFC

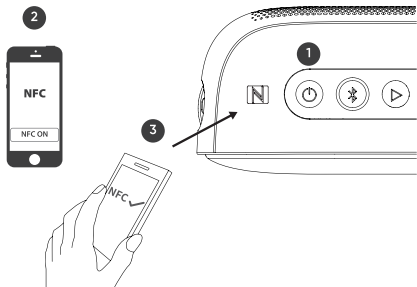



1. Assurez-vous que le haut-parleur est allumé.
2. Activez la fonction NFC dans votre téléphone.
3. Il faut que le NFC de votre téléphone soit proche du NFC du haut-parleur. Le téléphone reconnaît automatiquement l'enceinte et vous invite à la connecter. Cliquez sur "Accepter" pour terminer l'opération.

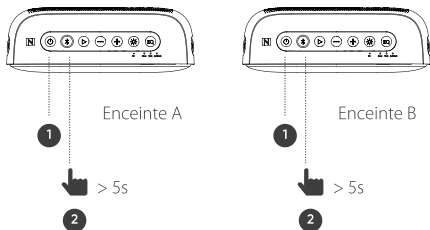

Mode de transmission





1. Assurez-vous que les deux enceintes sont allumées et connectez le haut-parleur A à l'appareil ;
2. Appuyez sur les deux haut-parleurs pendant 5 secondes pour passer en mode de transmission, et l'enceinte B se connectera automatiquement à l'enceinte A. Le mode de transmission est activé.
3. Si vous souhaitez connecter plusieurs haut-parleurs au groupe, appuyez sur le bouton Bluetooth 5S, le haut-parleur se connectera automatiquement au haut-parleur A.

Touches de commande





Fonction	Touche	Operation
Alimentation ON/ OFF		Appuyez sur la touche pour allumer ou éteindre le haut-parleur
Synchronisation Bluetooth		Appuyez sur la touche pour entrer manuellement dans le mode de synchronisation Bluetooth
Mode de transmission		Appuyez sur le bouton et maintenez-le enfoncé pendant 5 secondes pour passer en mode de transmission
Déconnexion du mode de transmission		Appuyez sur le bouton et maintenez-le enfoncé pendant 5 secondes pour déconnecter le mode de transmission
Lecture/Pause		Appuyez une fois sur la touche

Fonction	Touche	Operation
Piste suivante		Appuyez deux fois sur la touche
Piste précédente		Appuyez trois fois sur la touche
Fonction d'appel vocal		Appuyez sur la touche et maintenez-la enfoncée pendant 2 secondes pour l'activer (votre appareil doit être compatible avec cette fonction)
Répondre/ terminer un appel entrant		Appuyez une fois sur la touche
Rejeter un appel entrant		Appuyez et maintenez pendant 2 secondes
Baisser le volume		Appuyez sur la touche pour diminuer le niveau du volume
Augmenter le volume		Appuyez sur la touche pour augmenter le niveau du volume

Fonction	Touche	Operation
Régler la lumière		Appuyez sur le bouton pour modifier ou éteindre la lumière
Mode EQ (égaliseur)		Appuyez sur le bouton pour passer au mode Musique, au mode Basse et au mode Livre audio

Voyants

Voyant	Lumière	état
Voyant d'alimentation	Le voyant blanc reste allumé	Allumé
	Le voyant rouge clignote rapidement	Batterie faible
	Le voyant rouge reste allumé	Chargement (le voyant rouge s'éteint lorsque la batterie est chargée)

Voyant	Lumière	état
Voyant Bluetooth	Le voyant bleu  clignote rapidement	Mode connexion Bluetooth
	Le voyant bleu  clignote lentement	Connexion Bluetooth rétablie
	Le voyant bleu  reste allumé	Connecté
	Le voyant blanc  clignote rapidement	Mode de transmission
Voyants EQ	Le voyant XBass reste allumé	Mode basse activé
	Le voyant de musique reste allumé	Mode musique activé
	Le voyant Livre audio reste allumé	Mode livre audio activé

Réinitialisation

Si ce haut-parleur a un problème, vous pouvez essayer d'appuyer sur les boutons "Volume +" et "Volume -" en même temps pendant 5 secondes pour réinitialiser l'appareil et supprimer la précédente connexion Bluetooth, puis vous pouvez procéder à une nouvelle connexion.

Service à la clientèle

- * Garantie limitée de 18 mois
- * Pour les FAQ et de plus amples informations, veuillez vous adresser à
Courriel : support@tribit.com

Precauciones de seguridad

- * Evite las caídas.
- * No desmonte ni repare el altavoz.
- * Evite las temperaturas extremas.
- * No utilice el dispositivo al aire libre durante tormentas eléctricas.
- * No use ningún limpiador / aceite corrosivo para limpiarlo.

Especificaciones

Versión de Bluetooth: 5.0

Soporte: A2DP, AVRCP, HFP, HSP

Potencia de salida: 30 W

Respuesta de frecuencia: 60 Hz ~ 20 KHz

Rango de frecuencia: 2.402GHz~2.480GHz

Potencia máxima de transmisión: ≤ 6 dBm

Batería: 7.3V, 4000mAh, 29.2Wh

Tiempo de reproducción de música: Hasta 20 horas (varía con el nivel de volumen y los archivos de música)

Tiempo de carga: 4H

Entrada: DC 5V/2A

Resistente al agua: IPX7

Dimensiones: 250 mm x 87 mm x 80 mm

Peso: 1020g

¿Qué hay en la caja?



Altavoz
XSound Mega



Manual de usuario



Correa



Cable de carga USB-C



Cable de audio

Descripción general

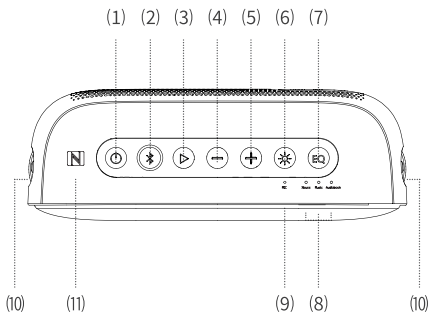

1. Botón de encendido
2. Botón de Bluetooth
3. MFB (Botón multifunción)
4. Volumen -
5. Volumen +
6. Botón de ajuste de luz

7. Botón de modo EQ
8. Indicadores de modo EQ
9. MIC (Micrófono)
10. Agujeros para colgar
11. NFC

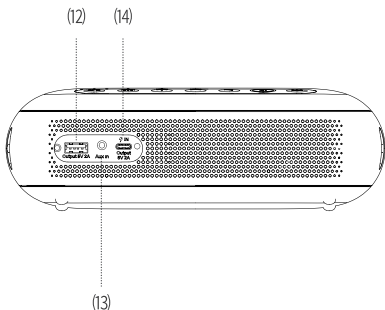

- 12. Puerto de carga USB-A (salida)
- 13. Puerto AUX-IN (auxiliar)
- 14. Puerto de carga USB-C (entrada / salida)

Conexiones

Carga del altavoz a otros dispositivos

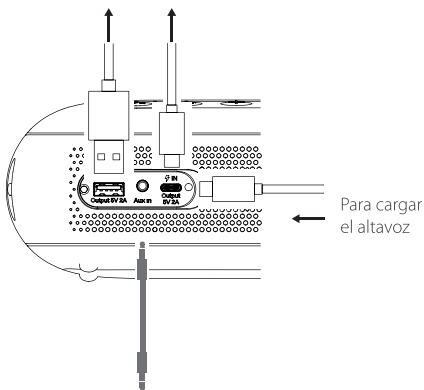

Entrada auxiliar

Emparejamiento Bluetooth

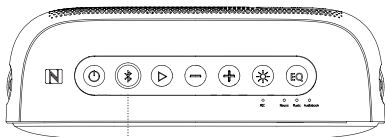

1



3

Conexión NFC

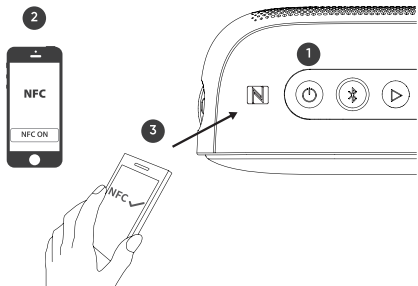



1. Asegúrese de que el altavoz esté encendido.
2. Abra NFC en su teléfono.
3. El área NFC del teléfono debe estar cerca del área NFC del altavoz. El teléfono reconocerá automáticamente el altavoz y solicitará el emparejamiento. Haga clic en "aceptar" para completar el emparejamiento.

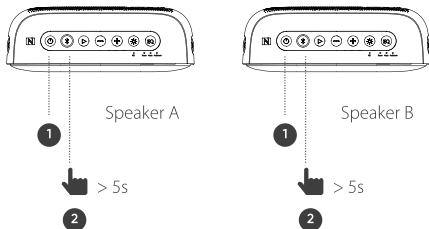



Modo de transmisión



1. Asegúrese de que ambos altavoces estén encendidos y conecte el altavoz A al dispositivo móvil.
2. Presione ambos altavoces durante 5 segundos para ingresar al modo de transmisión, y el altavoz B se conectará al altavoz A automáticamente. El modo de transmisión queda activado.
3. Si desea conectar varios altavoces al grupo, presione el botón Bluetooth 5S, el altavoz se conectará al altavoz A automáticamente.

Botones de control





Función	Botón	Uso
Encendido / Apagado		Presione el botón para encender / apagar el altavoz
Emparejar dispositivo Bluetooth		Presione el botón para entrar manualmente al modo de emparejamiento bluetooth
Modo de transmisión		Mantenga presionado el botón 5 segundos para entrar al modo de transmisión
Desconectar el modo de transmisión		Mantenga presionado el botón 5 segundos para desconectar el modo de transmisión
Play / Pausa		Presione una vez el botón
Siguiete pista		Presione dos veces el botón

Función	Botón	Uso
Pista anterior		Presione el botón 3 veces
Función de marcación por voz		Mantenga presionado el botón durante 2 segundos para activar (su dispositivo debe admitir esta función)
Responder / finalizar la llamada entrante		Presione una vez el botón
Rechazar una llamada entrante		Presione y mantenga 2 segundos
Bajar volumen		Presione el botón para disminuir el nivel de volumen
Subir volumen		Presione el botón para aumentar el nivel de volumen
Ajustes de luz		Presione el botón para encender o apagar la luz

Función	Botón	Uso
Modo EQ	EQ	Presione el botón para cambiar el modo de música, el modo de graves y el modo de audiolibro

Indicadores

Indicador	Luz	Estatus
Indicador de encendido	El indicador blanco se mantiene permanentemente encendido	Encendido
	El indicador rojo parpadea rápidamente	Batería baja
	El indicador rojo se mantiene permanentemente encendido	Cargando (el indicador rojo se apagará cuando la batería esté cargada)

Indicador	Luz	Estatus
Indicador de Bluetooth	El indicador azul  parpadea rápidamente	Modo de emparejamiento Bluetooth
	El indicador azul  parpadea lentamente	Reconexión de Bluetooth
	El indicador azul  se mantiene permanentemente encendido	Conectado
	El indicador blanco  parpadea rápidamente	Modo de emparejamiento de transmisión
Indicador de ecualizador	El indicador de graves se mantiene permanentemente encendido	El modo de graves está activado
	El indicador de música se mantiene permanentemente encendido	El modo música está activado

Indicador	Luz	Estatus
Indicador de ecualizador	El indicador de audiolibro se mantiene permanentemente encendido	El modo audiolibro está activado

Reiniciar

Si este altavoz tiene algún problema, puede intentar presionar y mantener presionados los botones "Volumen +" y "Volumen -" simultáneamente durante 5 segundos para restablecerlo, eliminar el emparejamiento anterior en su dispositivo Bluetooth y emparejar nuevamente.

Servicio al Cliente

- * Garantía limitada de 18 meses.
- * Para preguntas frecuentes y más información, visite:
Correo electrónico: support@tribit.com

Precauzioni di sicurezza

- * Evitare le cadute.
- * Non smontare o riparare l'altoparlante.
- * Evitare temperature estreme.
- * Non usare il dispositivo all'aperto durante i temporali.
- * Non usare detergenti/oli corrosivi per pulire.

Specifiche

Versione Bluetooth: 5.0

Supporto: A2DP, AVRCP, HFP, HSP

Potenza di uscita: 30W

Frequenza di risposta: 60Hz ~ 20KHz

limite di banda: 2.402GHz~2.480GHz

Potenza massima di trasmissione: $\leq 6\text{dBm}$

Batteria: 7.3V, 4000mAh, 29.2Wh

Tempo di riproduzione della musica: Fino a 20 ore (varia a seconda del volume e dei file musicali)

Tempo di ricarica: 4H a

Input: DC 5V/ 2A

Impermeabile: IPX7

Dimensioni: 250mm x 87mm x 80mm

Peso: 1020g

Cosa c'è nel pacco



XSound Mega



Manuale d'uso



Cinturino



Cavo di ricarica USB-C



Cavo Audio

Panoramica

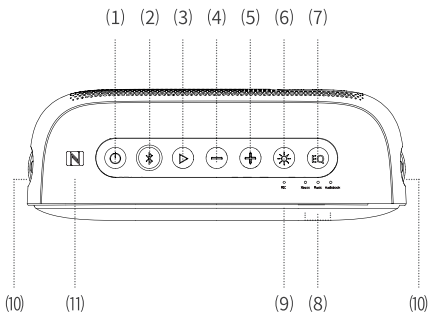

1. Pulsante di accensione
2. Pulsante Bluetooth
3. MFB
4. Volume -
5. Volume +
6. Pulsante di regolazione della luce

7. Pulsante modalità equalizzatore (EQ)
8. Indicatori modalità equalizzatore (EQ)
9. MIC
10. Fori di aggancio
11. NFC

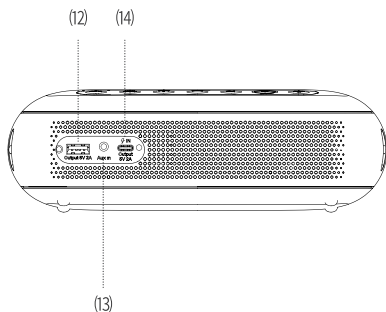

- 12. Porta di ricarica USB-A (uscita)
- 13. Porta AUX-IN
- 14. Porta di ricarica USB-C (ingresso / uscita)

Collegamenti

Carica dell'altoparlante su altri dispositivi

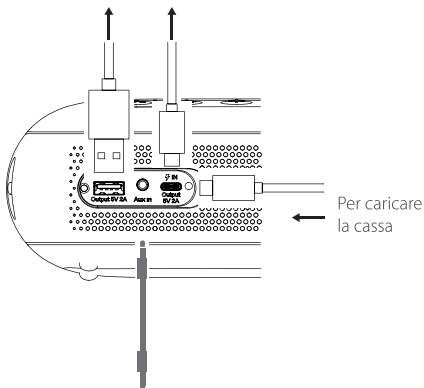

Entrata audio

Connessione Bluetooth

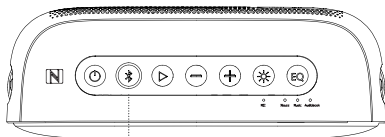

1



3

Connessione NFC

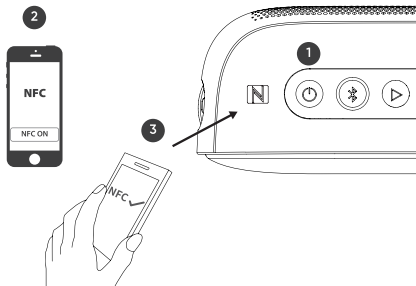

1. Assicurarsi che l'altoparlante sia acceso.
2. Aprire NFC nel telefono.
3. Bisogna che l'NFC del telefono sia vicino all'NFC dell'altoparlante. Il telefono riconoscerà automaticamente l'altoparlante e richiederà il collegamento. Fare clic su "Accetto" per completare l'operazione.

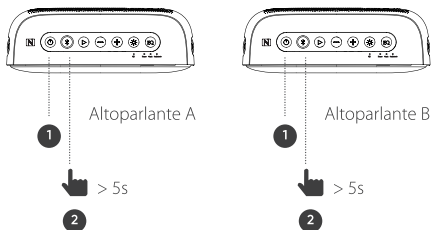

Modalità Trasmissione



1. Assicurarsi che entrambi gli altoparlanti siano accesi e collegare l'altoparlante A al dispositivo;
2. Premere entrambi gli altoparlanti per 5 secondi per entrare in modalità di trasmissione, e l'altoparlante B si collegherà automaticamente all'altoparlante A. La modalità di trasmissione è attiva.
3. se si desidera collegare più altoparlanti al gruppo, premere il pulsante Bluetooth 5S, l'altoparlante si collegherà automaticamente all'altoparlante A.

Pulsanti di controllo



Funzione	Tasto	Operazione
Alimentazione ON / OFF		Premere il pulsante per accendere / spegnere l'altoparlante
Sincronizzare il dispositivo Bluetooth		Premere il pulsante per entrare manualmente nella modalità di sincronizzazione bluetooth
Modalità Trasmissione		Tenere premuto il pulsante per 5 secondi per entrare in modalità trasmissione
Disconnessione dalla modalità trasmissione		Tenere premuto il pulsante per 5 secondi per disconnettere la modalità trasmissione
Play / Pausa		Premere il pulsante una volta
Traccia successiva		Premere il pulsante due volte

Funzione	Tasto	Operazione
Traccia precedente		Premere il pulsante tre volte
Funzione di chiamata vocale		Tenere premuto il pulsante per 2s per attivare (il vostro dispositivo deve supportare questa funzione)
Rispondere a/ chiudere una chiamata in arrivo		Premere il pulsante una volta
Rifiutare una chiamata in arrivo		Premere e tenere premuto per 2 secondi
Abbassare il volume		Premere il pulsante per diminuire il livello del volume
Alzare il volume		Premere il pulsante per aumentare il livello del volume

Funzione	Tasto	Operazione
Regolare la luce		Premere il pulsante per cambiare o spegnere la luce
Modalità EQ		Premere il pulsante per passare alla modalità Musica, alla modalità Bassi e alla modalità Audiolibro

Indicatori

Indicatore	Luce	Stato
Indicatore di alimentazione	L'indicatore bianco rimane acceso	Acceso
	L'indicatore rosso lampeggia velocemente	Batteria quasi scarica
	L'indicatore rosso rimane fisso	In carica (l'indicatore rosso si spegne quando la batteria è carica)

Indicatore	Luce	Stato
Indicatore-Bluetooth	L'indicatore blu  lampeggia velocemente	Modalità connessione Bluetooth
	L'indicatore blu  lampeggia lentamente	Riconnessione Bluetooth
	L'indicatore blu  rimane fisso	Connesso
	L'indicatore bianco  lampeggia velocemente	Modalità di trasmissione
Indicatore-Bluetooth	L'indicatore Xbass rimane fisso	Modalità bassi attiva
	L'indicatore della musica rimane fisso	Modalità musica attiva
	L'indicatore audiolibro rimane fisso	Modalità audiolibro attiva

Reset

Se questo altoparlante presenta qualche problema, si può tentare di tenere premuti i pulsanti "Volume +" e "Volume -" contemporaneamente per 5 secondi per resettare il dispositivo e rimuovere il vecchio collegamento Bluetooth, dopodiché si può procedere a un nuovo collegamento.

Servizio clienti

- * 18 mesi di garanzia limitata
- * Per le FAQ e ulteriori informazioni, si prega di:
Scrivere un'e-mail a: support@tribit.com