

# Tribit StormBox Pro

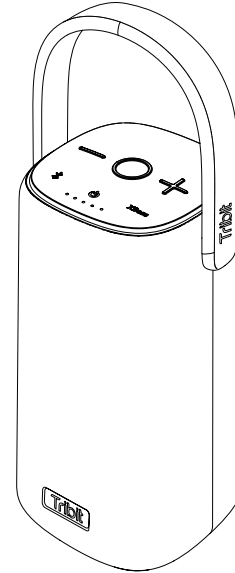

## Portable Wireless Speaker BTS31

English User Manual  
Benutzerhandbuch | Guide Utilisateur | Manual de Usuario  
Manuale Utente | 取扱説明書

Find more about Declaration of Conformity, please click the below link to download:  
<http://files.tribitaudio.com/bts31-uk-doc.pdf>

Um mehr über die Konformitätserklärung zu erfahren, klicken Sie bitte auf den  
folgenden Link: <http://files.tribitaudio.com/bts31-uk-doc.pdf>

English User Manual	01
Benutzerhandbuch	15
Guide Utilisateur	27
Manual de Usuario	39
Manuale Utente	51
取扱説明書	63

## Packing List

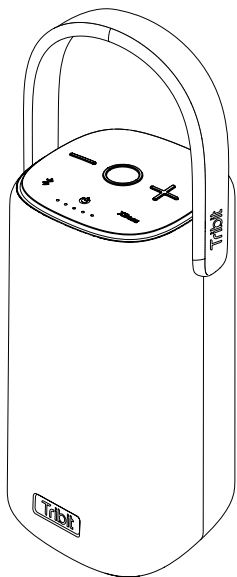

StormBox Pro

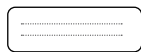

Warranty Card

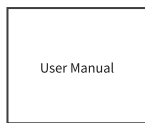

User Manual



USB-C charging cable

1

## Product Illustration

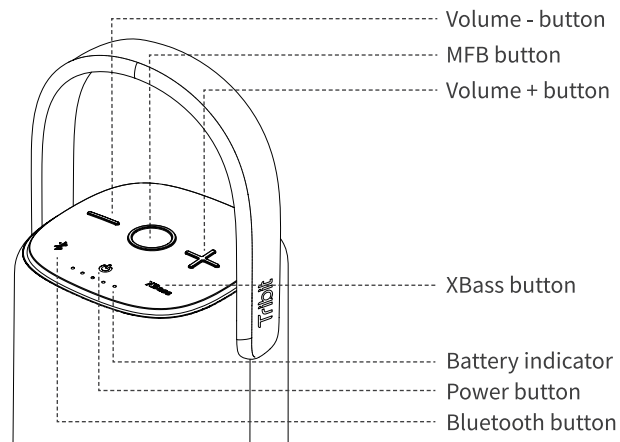

Charging out

Charging in

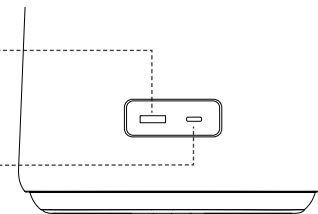

2

# Charging

## 1. To Charge the Speaker

Connect this speaker to a 5V power outlet via the providing USB-C charging cable.

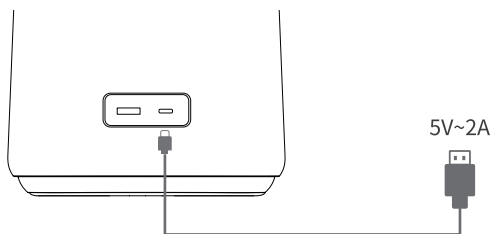

## 2.To Charge Other Devices

Connect the speaker with your USB-enabled device via a USB-A charging cable(not included).

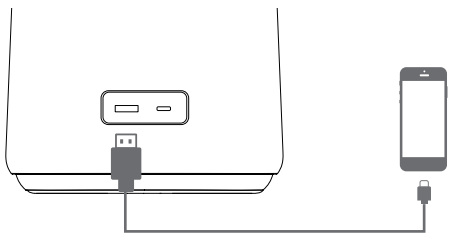

3

## 3.Charging Indicator

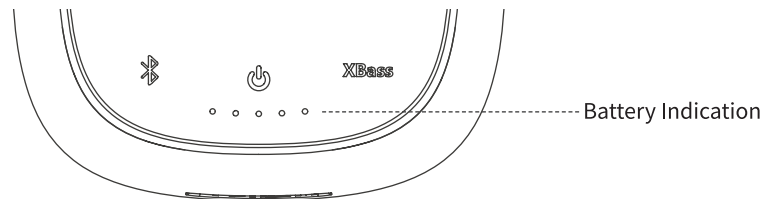

	Red indicator is flashing	Low battery
	White indicator is flashing	Charging
	All indicators turn off	Fully charged

## 4.Battery Indication

10-30%	30-50%	50-70%	70-80%	80-100%	Fully charged

4

# Button Controls

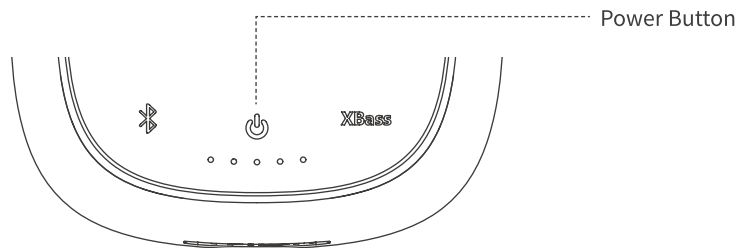

## 1. Power on/off

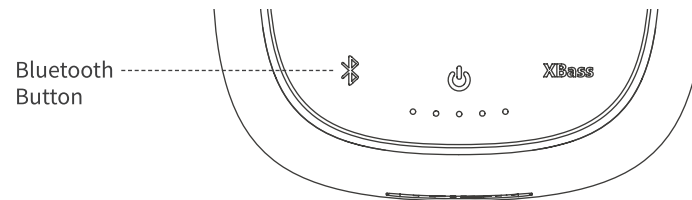

	Short press	Power on		White indicator is on
	Short press	Power off		All indicators turn off
	Press and hold it for 10s	Forcibly shut down		All indicators turn off

## 2. Bluetooth Connection



	Press and hold it for 2s	Enters pairing mode		Blue indicator is flashing	Pairing status
---	--------------------------	---------------------	---	----------------------------	----------------

- The StormBox Pro Speaker will automatically connect to the last 2 paired devices again if available. If it fails, the speaker will enter to pairing mode.
- You can connect this speaker with multiple devices and control the connection via  Bluetooth button.
- The speaker can remember up to 8 paired Bluetooth devices.
- Better still, it can connect to 2 devices simultaneously at a time.

### 3. Conversion between 2 Connected Devices

- 1) Pause the playback of the current device
- 2) Play the audio file of the other device

### 4. Volume Adjustment

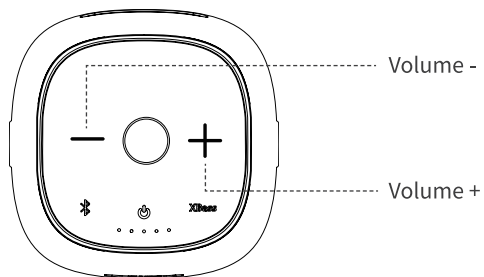

-	Short press	Decrease volume
	Keep it pressed for seconds	Continuously decrease volume
+	Short press	Increase volume
	Keep it pressed for seconds	Continuously increase volume

### 5. Multifunctional Button (MFB)

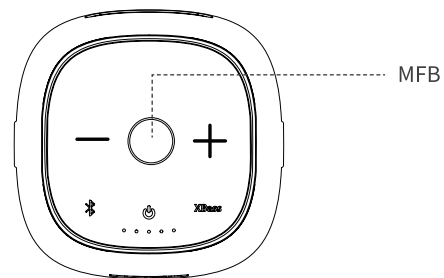

	Music Mode	Short press	Play/Pause
		Double press	Next Track
		Press it for 3 times	Previous Track
		Press and hold it for 1s	Activate Siri
	Conversation Mode	Short press	Answer / End phone call
		Press and hold it for 1s	Reject phone call
		Short press	Pause the current call and answer the incoming call
		Short press	Switch between two phone calls

## 6.XBass Function

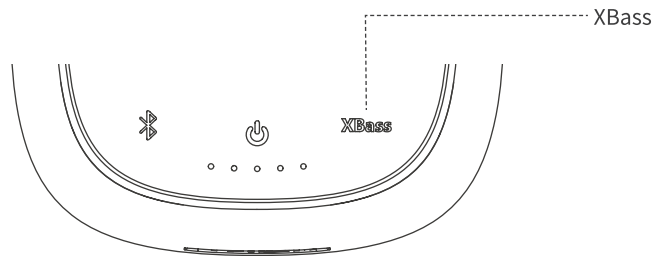

Short press the **XBass** button to activate the XBass function, then the XBass indicator will glow white.

Short press this button again to turn off the XBass function, and the XBass indicator will light off.

## 7.Party Mode

1) Make sure both of two speakers are turned on.

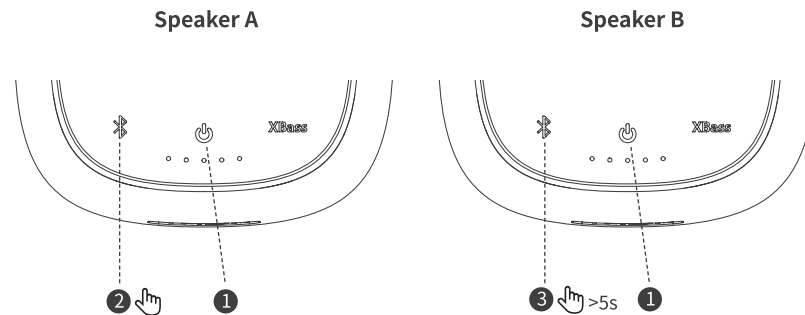

2) Press and hold the **Bluetooth** button of one speaker for 5s to enter pairing status, then press and hold the **Bluetooth** button of the other speaker for 5s to search for Bluetooth devices. At this time, you'll hear a "Party mode" sound and the speakers enter party mode.

**Note:** The function of party mode can be realized only when you have 2 Tribit StormBox Pro speakers.

## 8. Stereo Mode

1) Make sure both two speakers have entered party mode.

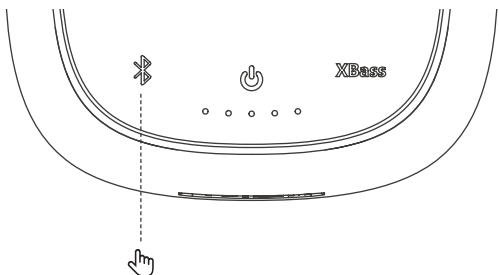

2) Short press the  button on any of the two speakers.

3) When you hear the voice of “Stereo Mode”, one speaker sounds “Left Channel” and the other sounds “Right Channel”, the stereo mode is activated.

**Note:** The function of stereo mode can be realized only when you have 2 Tribit StormBox Pro speakers.

## 9. Conversion between Party Mode and Stereo Mode

Short press the  button on any of the two speakers.

## 10. Disable the Party Mode or Stereo Mode

Press and hold the  button for 5s on any of the two speakers, then both will re-enter Bluetooth pairing mode.

## 11. Factory Reset

Press and hold the Volume  and  button for 5s simultaneously to clear the pairing list and all settings, and the speaker will restore factory state.

# Specifications

Bluetooth Version	5.0
Output Power	40W
Frequency	60Hz-20KHz
Battery Type	7.4V/5000mAh Lithium battery
Charging Time	7 hours @5V/2A
Dimensions	96 x 96 x 180 mm
Waterproof Grade	IP67



## FCC Statement

Changes or modifications not expressly approved by the party responsible for compliance could void the user's authority to operate the equipment.

This equipment has been tested and found to comply with the limits for a Class B digital device, pursuant to Part 15 of the FCC Rules. These limits are designed to provide reasonable protection against harmful interference in a residential installation. This equipment generates uses and can radiate radio frequency energy and, if not installed and used in accordance with the instructions, may cause harmful interference to radio communications. However, there is no guarantee that interference will not occur in a particular installation. If this equipment does cause harmful interference to radio or television reception, which can be determined by turning the equipment off and on, the user is encouraged to try to correct the interference by one or more of the following measures:

- Reorient or relocate the receiving antenna.
- Increase the separation between the equipment and receiver.
- Connect the equipment into an outlet on a circuit different from that to which the receiver is connected.
- Consult the dealer or an experienced radio/TV technician for help

This device complies with part 15 of the FCC rules. Operation is subject to the following two conditions (1) this device may not cause harmful interference, and (2) this device must accept any interference received, including interference that may cause undesired operation.

Qualcomm aptX is a product of Qualcomm Technologies, Inc. and/or its subsidiaries. Qualcomm is a trademark of Qualcomm Incorporated, registered in the United States and other countries. aptX is a trademark of Qualcomm Technologies International, Ltd., registered in the United States and other countries.

## Packliste

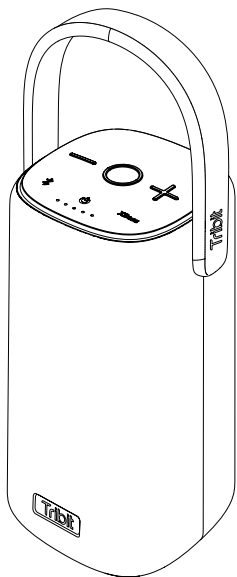

StromBox Pro



Garantiekarte

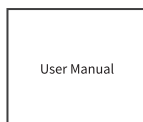

Bedienungsanleitung



USB-C Ladekabel

## Produkt-Abbildung

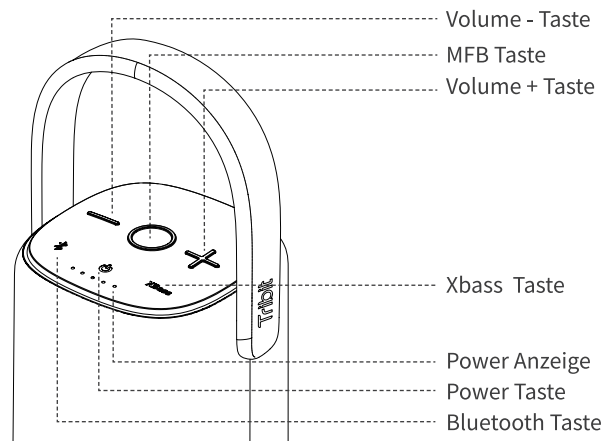

Ladeausgang

Ladeeingang

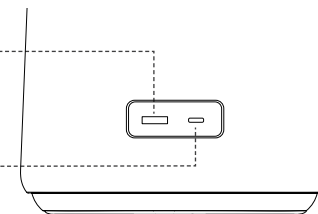

# Laden

## 1. Um den Lautsprecher aufzuladen

Schließen Sie diesen Lautsprecher über das mitgelieferte USB-C-Ladekabel an eine 5-V-Steckdose an.

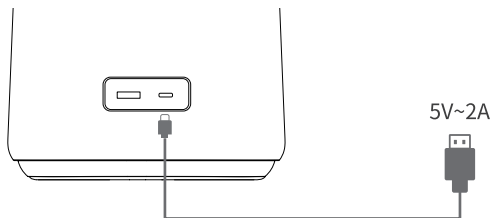

## 2. Um andere Geräte aufzuladen

Verbinden Sie den Lautsprecher mit Ihrem USB-fähigen Gerät über ein USB-A-Ladekabel (nicht im Lieferumfang enthalten).

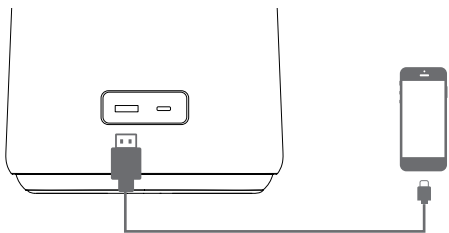

## 3. Ladeanzeige

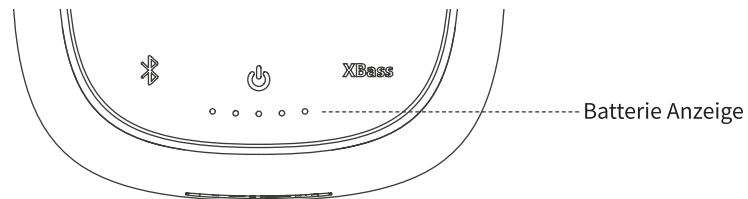

	Rote Anzeige blinkt	Batterie schwach
	Weißer Anzeige blinkt	Aufladen
	Alle Anzeigen schalten sich aus	Vollständig geladen

## 4. Battery Indication

10-30%	30-50%	50-70%	70-80%	80-100%	Vollständig geladen

# Schaltflächen-Steuerlemente

## 1. Power on/off

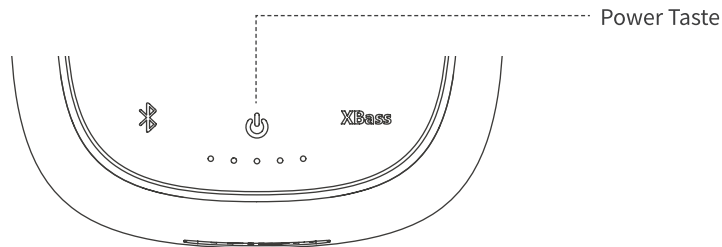

	Kurzes Drücken	Einschalten		Weißer Anzeige leuchtet
	Kurzes Drücken	Ausschalten		Alle Anzeigen schalten sich aus
	Halten Sie die Taste 10 Sekunden lang gedrückt.	Gewaltsame Abschaltung		Alle Anzeigen schalten sich aus

## 2. Bluetooth Connection

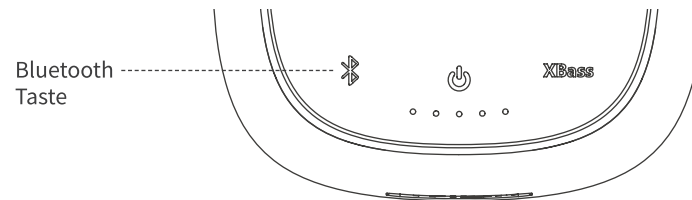

	Drücken Sie die Taste und halten Sie sie 2 Sekunden lang gedrückt.	Eintritt in den Kopplungsmodus		Blaue Anzeige blinkt	Status der Kopplung
---	--	--------------------------------	---	----------------------	---------------------

- Der StormBox Revolution Lautsprecher stellt automatisch wieder eine Verbindung zu den letzten beiden gekoppelten Geräten her, falls verfügbar. Wenn dies fehlschlägt, wechselt der Lautsprecher in den Verbindungsmodus.
- Sie können diesen Lautsprecher mit mehreren Geräten verbinden und die Verbindung über die  Bluetooth-Taste steuern.
- Der Lautsprecher kann sich bis zu 8 gepaarte Bluetooth-Geräte merken.
- Besser noch, er kann mit 2 Geräten gleichzeitig eine Verbindung herstellen.

### 3. Konvertierung zwischen 2 angeschlossenen Geräten

- 1) Pausieren der Wiedergabe des aktuellen Geräts.
- 2) Spielen Sie die Audiodatei des anderen Geräts.

### 4. Volumen-Anpassung

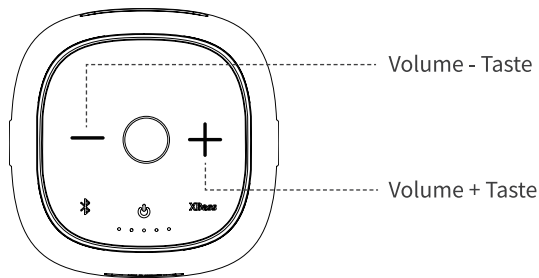

-	Kurzes Drücken	Lautstärke verringern
	Sekundenlang gedrückt halten	Kontinuierliche Verringerung des Volumens
+	Kurzes Drücken	Volumen erhöhen
	Sekundenlang gedrückt halten	Kontinuierliche Erhöhung des Volumens

### 5. Multifunctional Taste (MFB)

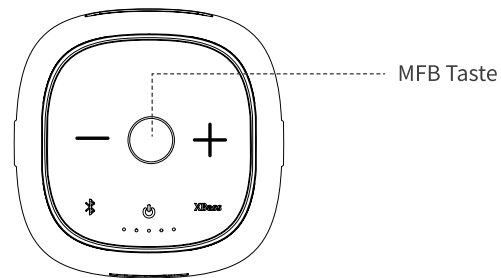

	Musik-Modus	Kurzes Drücken	Abspielen/Pause
		Doppelte Presse	Nächster Track
		3 Mal drücken	Vorheriger Track
		Drücken und 1s lang halten	Siri aktivieren
	Konversationsmodus	Kurzes Drücken	Telefongespräch beantworten / beenden
		Drücken und 1s lang halten	Telefonanruf ablehnen
		Kurzes Drücken	Halten Sie den aktuellen Anruf an und beantworten Sie den eingehenden Anruf
		Kurzes Drücken	Zwischen zwei Telefongesprächen umschalten

## 6. XBass Funktion

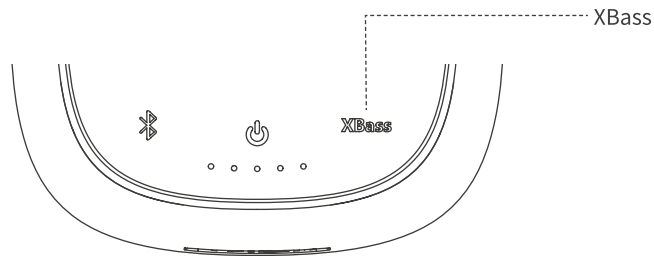



Drücken Sie kurz auf die XBass-Taste, um die XBass-Funktion zu aktivieren, dann leuchtet die XBass-Anzeige weiß.

Drücken Sie diese Taste erneut kurz, um die XBass-Funktion auszuschalten, dann leuchtet die XBass-Anzeige nicht mehr.

## 7. Party Modus

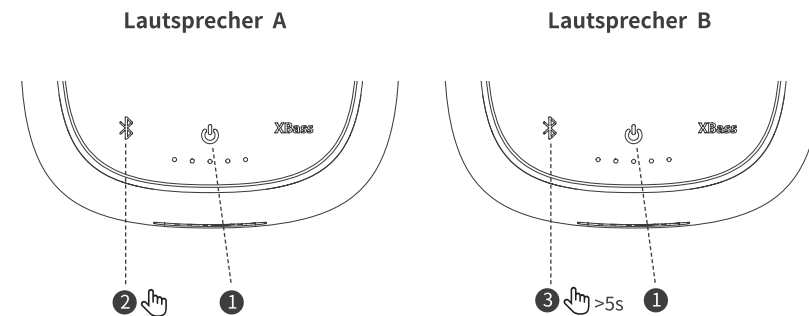
1) Stellen Sie sicher, dass beide von zwei Lautsprechern eingeschaltet sind.



2) Halten Sie die Bluetooth-Taste  eines Lautsprechers 5s lang gedrückt, um den Paarungsstatus aufzurufen, und drücken Sie dann die Bluetooth-Taste  des anderen Lautsprechers 5s lang, um nach Bluetooth-Geräten zu suchen. Zu diesem Zeitpunkt hören Sie einen "Party-Modus" und die Lautsprecher wechseln in den Party-Modus.

**Hinweis:** Die Funktion des Party-Modus kann nur realisiert werden, wenn Sie 2 Tribit Stormbox Pro-Lautsprecher haben.

## 8. Stereo Modus

1) Vergewissern Sie sich, dass beide zwei Lautsprecher in den Party-Modus gegangen sind.

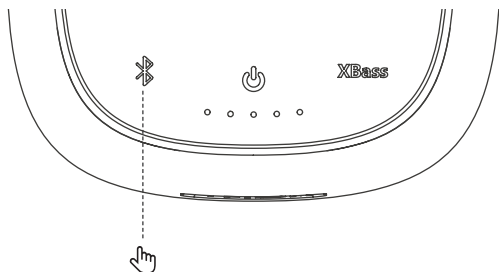

2) Drücken Sie kurz die Bluetooth-Taste an einem der beiden Lautsprecher.

3) Wenn Sie die Stimme des Stereomodus hören, ein Lautsprecher „Linker Kanal“ und der andere „Rechter Kanal“ ertönt, wird der Stereomodus aktiviert.

**Hinweis:** Die Funktion des Stereomodus kann nur realisiert werden, wenn Sie 2 Tribit StormBox Pro-Lautsprecher haben.

## 9. Konvertierung zwischen Party-Modus und Stereo-Modus

Drücken Sie kurz die Bluetooth-Taste an einem der beiden Lautsprecher.

## 10. Deaktivieren des Party- oder Stereomodus

Halten Sie die Lautstärketaste + und - 5 Sekunden lang gleichzeitig gedrückt, um die Paarungsliste und alle Einstellungen zu löschen, und der Lautsprecher stellt den Werkszustand wieder her.

## 11. Werksrückstellung

Halten Sie die Lautstärketaste + und - 5 Sekunden lang gleichzeitig gedrückt, um die Paarungsliste und alle Einstellungen zu löschen, und der Lautsprecher stellt den Werkszustand wieder her..

# Spezifikationen

Bluetooth-Version	5.0
Ausgangsleistung	40W
Häufigkeit	60Hz-20KHz
Batterie-Typ	7.4V/5000mAh Lithium batterie
Aufladezeit	7 stunden @5V/2A
Abmessungen	96 x 96 x 180 mm
Wasserdichte Sorte	IP67

## Contenu du colis

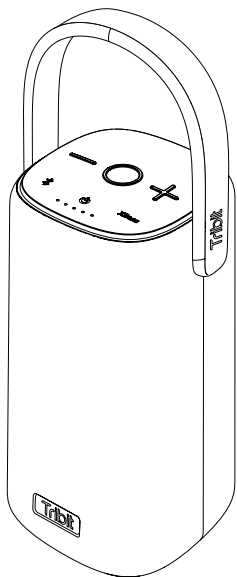

StromBox Pro

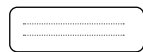

Carte de garantie

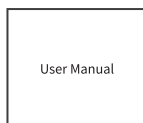

Manuel d'utilisation



Câble de chargement USB-C

## Présentation du produit

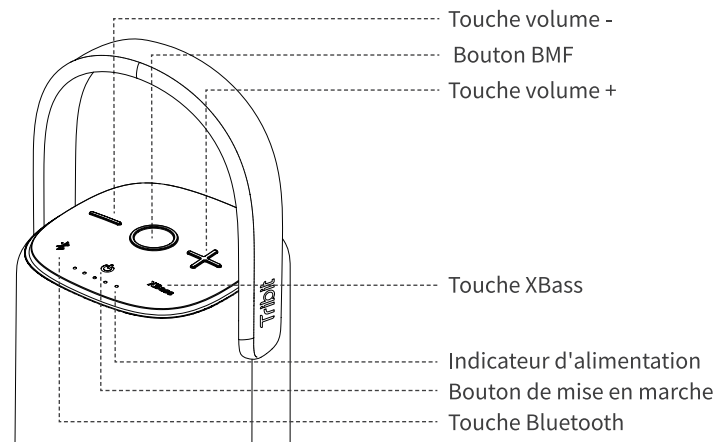

Recharger la batterie

Mise en charge

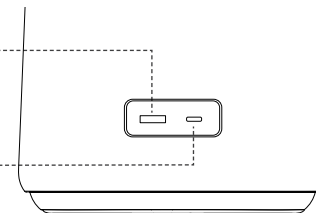



# Chargement

## 1. Charger le haut-parleur

Connectez ce haut-parleur à une prise de courant de 5V par le câble de chargement USB-C fourni.

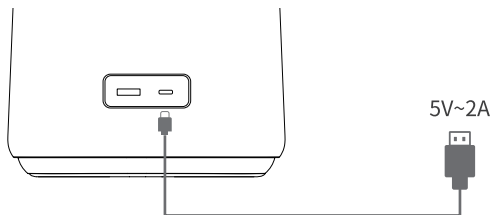

## 2. Charger d'autres appareils

Connectez le haut-parleur à votre dispositif USB par un câble de chargement USB-A (non inclus).

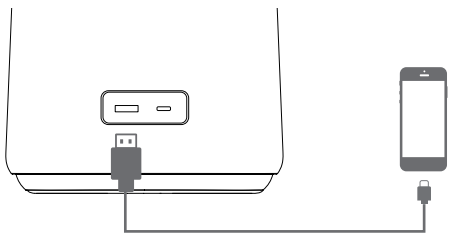

## 3. Indicateur de charge

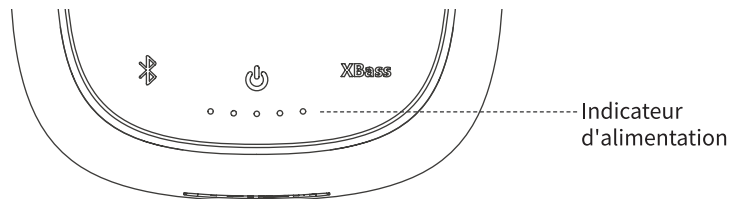

	Le voyant rouge clignote	Batterie faible
	Le voyant blanc clignote	En charge
	Tous les voyants s'éteignent	Entièrement chargé

## 4. Battery Indication

10-30%	30-50%	50-70%	70-80%	80-100%	Entièrement chargé

# Boutons de commande

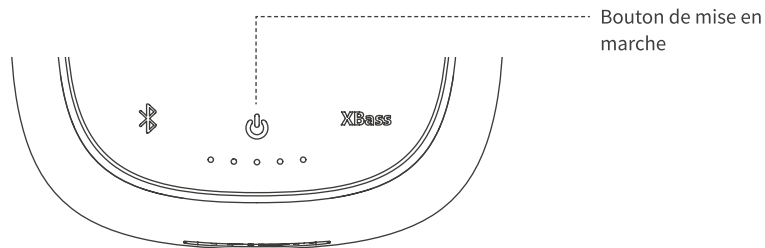

## 1. Mise en marche/arrêt

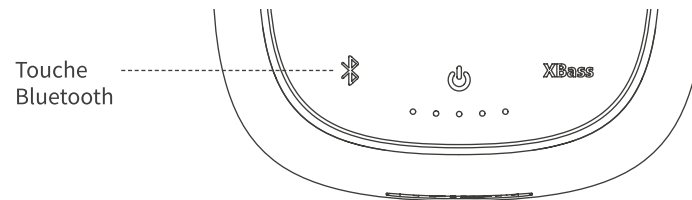

	Appuyer brièvement	Mise en marche		Le voyant blanc est allumé
	Appuyer brièvement	Arrêt		Tous les voyants s'éteignent
	Appuyer et maintenir pendant 10 secondes	Arrêt forcé		Tous les voyants s'éteignent

## 2. Connection Bluetooth



	Appuyer et maintenir pendant 2s	Entre en mode d'appariement		Le voyant bleu clignote	État d'appariement
---	---------------------------------	-----------------------------	---	-------------------------	--------------------

- Le haut-parleur StormBox Pro se connectera automatiquement aux deux derniers appareils appariés, s'ils sont disponibles. En cas d'échec, il passera en mode d'appariement.
- Vous pouvez connecter ce haut-parleur à plusieurs appareils et contrôler la connexion par le bouton Bluetooth  .
- Le haut-parleur peut mémoriser jusqu'à 8 appareils Bluetooth appariés.
- Mieux encore, il peut se connecter à 2 appareils simultanément.

### 3. Passage entre 2 appareils connectés

- 1) Mettez en pause la reproduction de l'appareil en cours.
- 2) Faites jouer le fichier audio de l'autre appareil.

### 4. Ajustement du volume

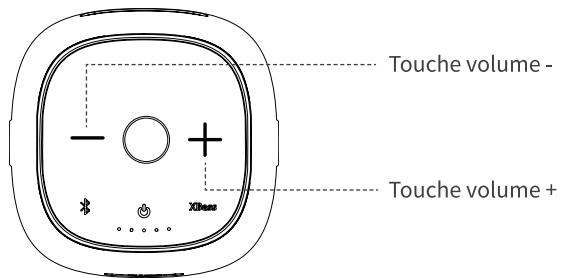

-	Appuyer brièvement	Diminuer le volume
	Maintenir la pression pendant quelques secondes	Diminuer continuellement le volume
+	Appuyer brièvement	Augmenter le volume
	Maintenir la pression pendant quelques secondes	Augmenter continuellement le volume

### 5. Bouton multifonctionnel (BMF)

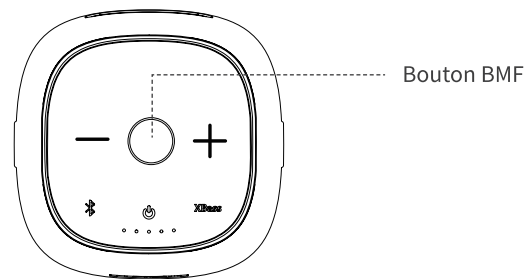

	Mode Musique	Brève pression	Jeu/Pause
		Double pression	Prochaine morceau
		Appuyer 3 fois sur le bouton	Morceau précédent
		Appuyer et maintenir pendant 1s	Activer Siri
	Mode conversation	Brève pression	Répondre / Mettre fin à l'appel
		Appuyer et maintenir pendant 1s	Rejeter l' appel
		Brève pression	Pause de l'appel en cours et réponse à l'appel entrant
		Brève pression	Passer d'un appel téléphonique à l'autre

## 6.Fonction XBass

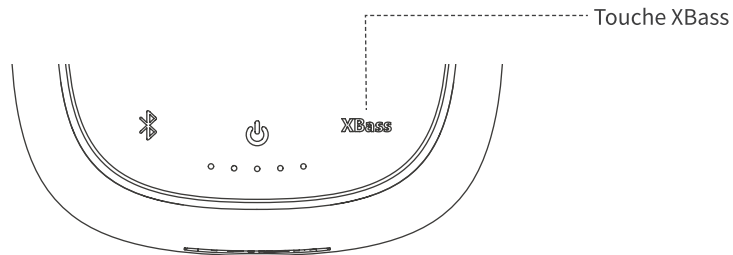

Appuyez brièvement sur le bouton XBass pour activer la fonction XBass, puis son voyant s'allumera en blanc.

Appuyez brièvement sur ce bouton pour désactiver la fonction XBass, et le voyant s'éteindra.

## 7.Mode fête

1) Assurez-vous que les deux haut-parleurs sont allumés.

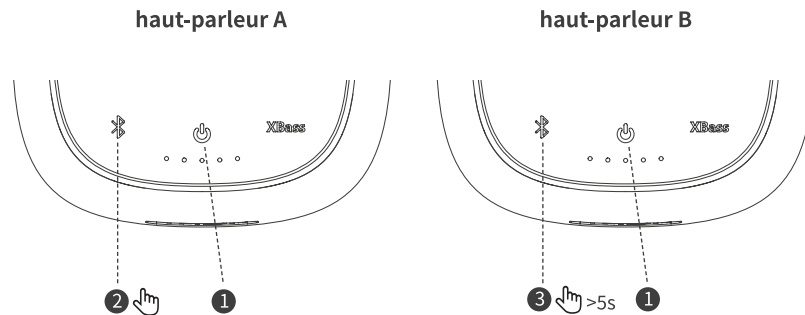

2) Appuyez et maintenez le bouton Bluetooth d'un haut-parleur pendant 5 secondes pour entrer dans le mode de couplage, puis appuyez et maintenez le bouton Bluetooth de l'autre haut-parleur pendant 5 secondes pour rechercher des périphériques Bluetooth. À ce moment, vous entendrez le son " Party mode " et les haut-parleurs passeront en mode fête.

**Note :** La fonction du mode fête ne peut être réalisée que lorsque vous disposez de 2 haut-parleurs Tribit StormBox Pro.

## 8. Mode stéréo

1) Assurez-vous que les deux haut-parleurs sont en mode " party ".

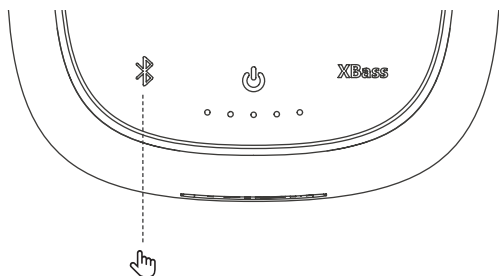

2) Appuyez brièvement sur le bouton Bluetooth de l'un des deux haut-parleurs.

3) Lorsque vous entendez la voix de Stereo Mode, un haut-parleur sonne "Left Channel" et l'autre sonne "Right Channel", le mode stéréo est activé.

**Note :** La fonction du mode stéréo ne peut être réalisée que lorsque vous disposez de 2 haut-parleurs Tribit StormBox Pro.

## 9. Conversion entre le mode fête et le mode stéréo

Appuyez brièvement sur le bouton Bluetooth de l'un des deux haut-parleurs.

## 10. Désactiver le mode fête ou le mode stéréo

Appuyez sur le bouton Bluetooth et maintenez-le enfoncé pendant 5s sur l'un des deux haut-parleurs, puis les deux reviendront en mode de couplage Bluetooth.

## 11. Réinitialisation

Appuyez simultanément sur les boutons Volume+ et — pendant 5s pour effacer la liste d'appariement et tous les réglages, et le haut-parleur retrouvera son état d'origine.

# Caractéristiques

Version Bluetooth	5.0
Puissance de sortie	40W
Fréquence	60Hz-20KHz
Type de batterie	Pile au lithium 7,4V/5000mAh
Temps de chargement	7 heures à 5V/2A
Dimensions	96 x 96 x 180 mm
Degré d'étanchéité	IP67

## Contenido del paquete

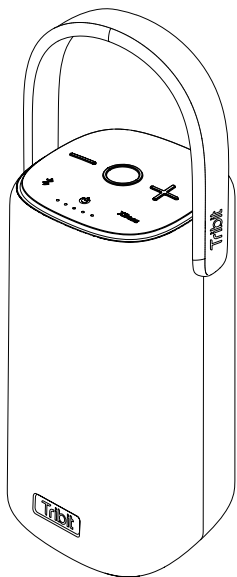

StromBox Pro



Tarjeta de Garantía

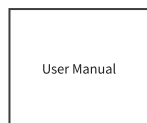

Manual de Usuario



Cable de carga USB-C

## Ilustración del producto

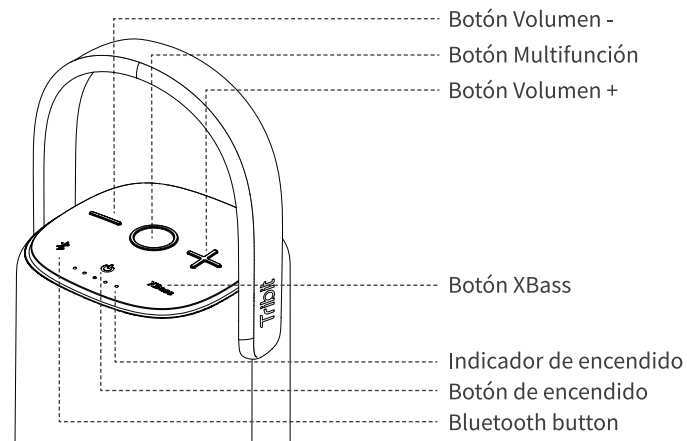

Carga finalizada

Carga en curso

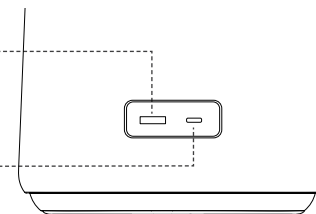

# Carga

## 1. Para cargar el altavoz

Conecte el altavoz a una toma de corriente de 5V a través del cable de carga USB-C.

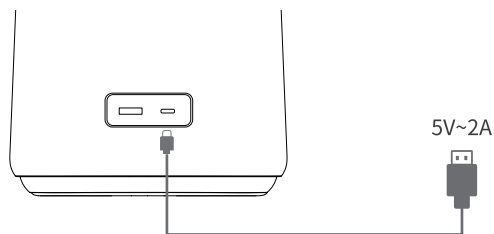

## 2. Para cargar otros dispositivos

Conecte el altavoz con su dispositivo con USB a través de un cable de carga USB-A (no incluido).

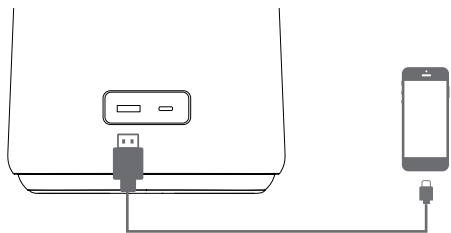

## 3. Indicador de carga

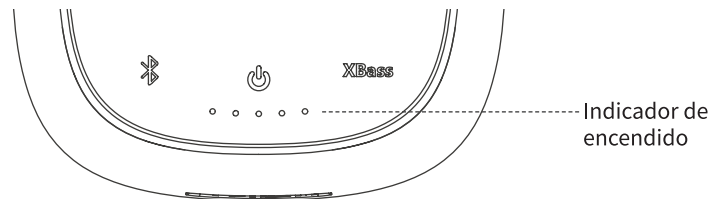

	El indicador rojo parpadea.	Batería baja
	El indicador blanco parpadea.	Cargando
	Todos los indicadores se apagan	Carga completa

## 4. Indicador de batería

10-30%	30-50%	50-70%	70-80%	80-100%	Carga completa

# Controles de botones

## 1. Encendido / apagado

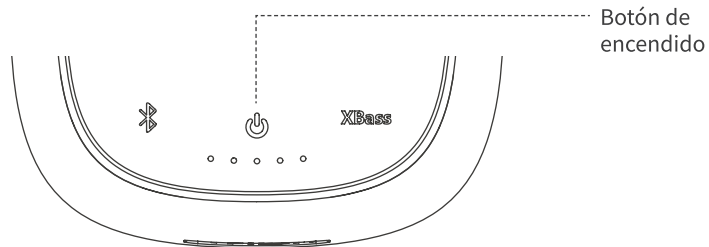

	Pulsación corta	Encendido		El indicador blanco está encendido
	Pulsación corta	Apagado		Todos los indicadores se apagan
	Presiona y mantén durante 10 segundos	Forcibly shut down		Todos los indicadores se apagan

## 2. Conexión Bluetooth

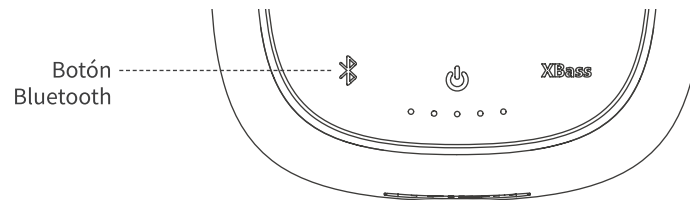

	Mantenga presionado durante 2 segundos	Entra en modo de emparejamiento		El indicador azul parpadea	Estado de emparejamiento
--	--	---------------------------------	--	----------------------------	--------------------------

- El altavoz StormBox Pro se conectará automáticamente a los últimos 2 dispositivos emparejados nuevamente si están disponibles. Si falla, el altavoz se pondrá en modo emparejamiento.
- Puede conectar este altavoz con múltiples dispositivos y controlar la conexión a través del botón Bluetooth
- El altavoz puede recordar hasta 8 dispositivos Bluetooth emparejados.
- Además, se puede conectar a 2 dispositivos simultáneamente.



### 3. Cambio entre 2 dispositivos conectados

- 1) Pausa la reproducción del dispositivo actual.
- 2) Reproduzca el archivo de audio del otro dispositivo.

### 4. Ajuste del volumen

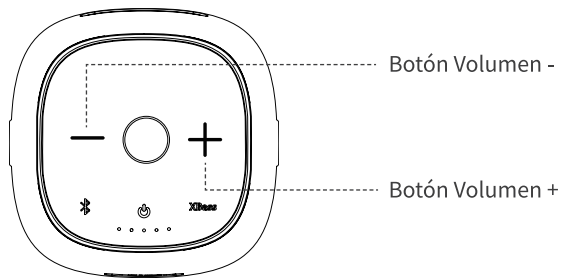

-	Pulsación corta	Disminuir el volumen
	Mantenerlo presionado por segundos	Disminuir continuamente el volumen
+	Pulsación corta	Aumentar el volumen
	Mantenerlo presionado por segundos	Aumentar continuamente el volumen

### 5. Botón Multifunción

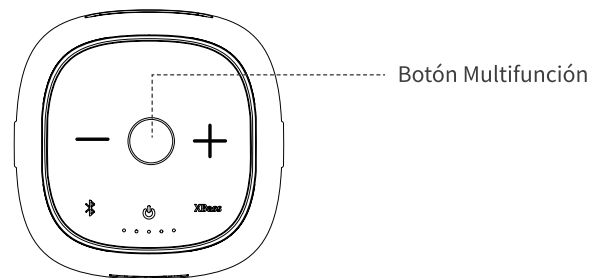

	Modo música	Pulsación corta	Play/Pausa
		Doble pulsación	Siguiente pista
		Mantenga presionado 3 segundos	Pista anterior
		Mantenga presionado 1 segundo	Activar Siri
	Modo conversación	Pulsación corta	Contestar / finalizar llamada
		Mantenga presionado 1 segundo	Rechazar la llamada
		Pulsación corta	Pausa la llamada actual y contesta la llamada entrante
		Pulsación corta	Cambiar entre dos llamadas telefónicas

## 6. Función XBass

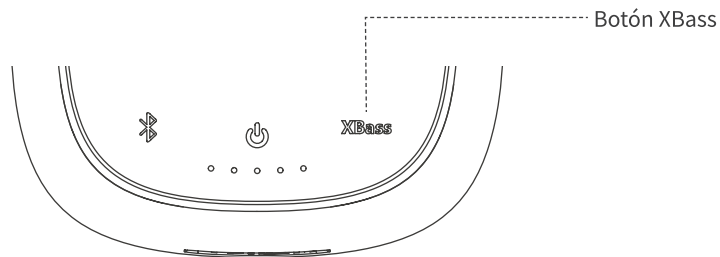

Presione brevemente el botón XBass para activar la función XBass, el indicador se iluminará en blanco.

Presione brevemente este botón nuevamente para apagar la función XBass, y el indicador XBass se apagará.

## 7. Modo fiesta

1) Asegúrese de que ambos altavoces estén encendidos.

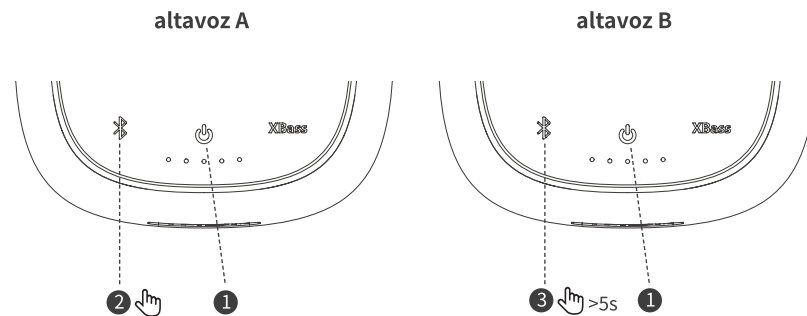

2) Mantenga presionado el botón Bluetooth de un altavoz durante 5 segundos para ingresar al modo de emparejamiento, luego presione y mantenga presionado el botón Bluetooth del otro altavoz durante 5 segundos para buscar dispositivos Bluetooth. En este momento, escuchará el sonido "Party Mode" y los altavoces entrarán en modo fiesta.

**Nota:** Esta función solo se puede realizar entre 2 altavoces Tribit Stormbox Pro.

## 8. Modo Stereo

1) Asegúrese de que los dos altavoces estén en modo fiesta.

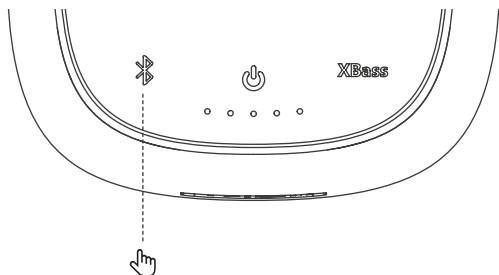

2) Presione brevemente el botón Bluetooth en cualquiera de los dos altavoces.

3) Cuando establezca el modo estéreo, un altavoz dirá "Left Channel" y el otro "Right Channel"; entonces se activará el modo estéreo.

**Nota:** La función estéreo solo se puede realizar entre 2 altavoces Tribit StormBox Pro.

## 9. Cambio entre modo fiesta y modo estéreo

Presione brevemente el botón Bluetooth en cualquiera de los dos altavoces.

## 10. Desactivar el modo fiesta o el modo estéreo

Mantenga presionado el botón Bluetooth durante 5 segundos en cualquiera de los dos altavoces, luego ambos volverán al modo de emparejamiento Bluetooth.

## 11. Restablecimiento de fábrica

Mantenga presionado el botón Volumen + y - durante 5 segundos a la vez para borrar la lista de emparejamiento y todas las configuraciones, y el altavoz restaurará el estado de fábrica.

# Especificaciones

Versión Bluetooth	5.0
Potencia de salida	40W
Frecuencia	60Hz-20KHz
Tipo de batería	Batería de litio de 7.4V / 5000mAh
Tiempo de carga	7 horas a 5V / 2A
Dimensiones	96 x 96 x 180 mm
Grado de impermeabilidad	IP67

## Contenuto della Confezione

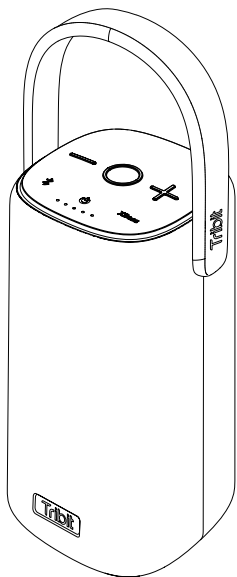

StormBox Pro

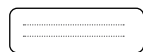

Carta Garanzia

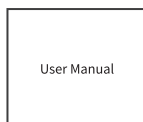

Manuale Utente



cavo di ricarica USB-C

## Illustrazione Prodotto

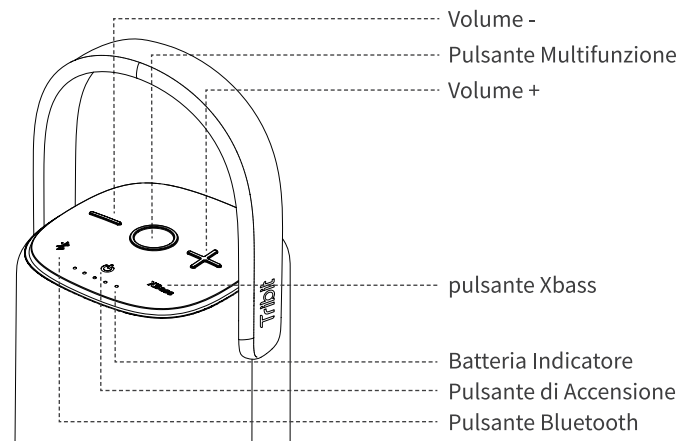

uscita di carica

ingresso di ricarica

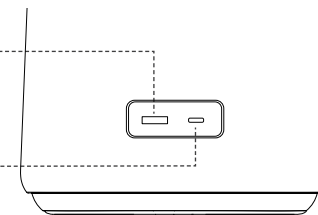

# Ricaricare

## 1. Ricaricare l'Altoparlante

Connetti questo altoparlante con una presa alimentatore da 5V tramite il cavo di ricarica USB-C fornito.

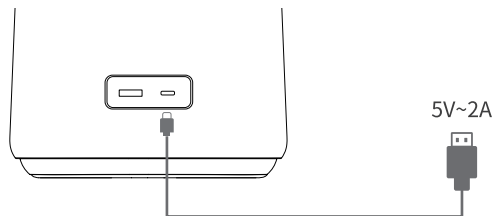

## 2.2. Caricare gli Altri Dispositivi

Connettere l'altoparlante con il dispositivo abilitato USB via cavo di ricarica USB-A (non incluso).

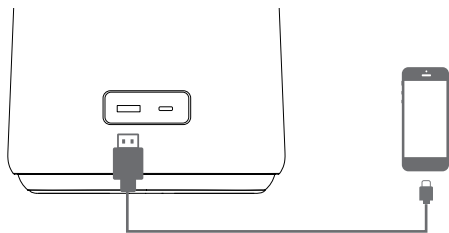

## 3. Indicatore di Ricarica

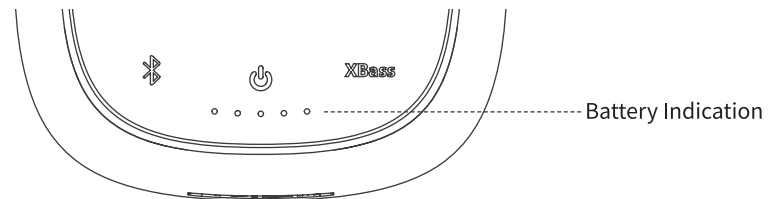

	L'indicatore rosso lampeggia	Batteria bassa
	L'indicatore bianco lampeggia	Ricarica
	Tutti gli indicatori sono spenti	Ricarica completa



## 4. Battery Indication

10-30%	30-50%	50-70%	70-80%	80-100%	Ricarica completa

# Pulsanti di Controllo

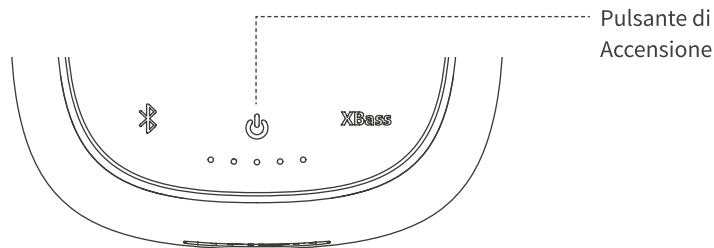
## 1. Accensione/Spegnimento



	Pressione breve	Accensione		L'indicatore bianco è acceso
	Pressione breve	Spegnimento		Tutti gli indicatori sono spenti
	10s Premere e tenere premuto per 10 secondi	Forcibly shut down Forzare lo spegnimento		All indicators turn off Tutti gli indicatori sono spenti

## 2. Connessione Bluetooth

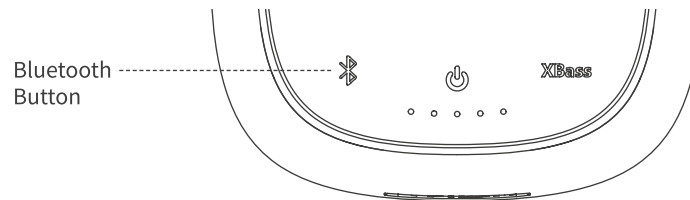

	Press and hold it for 2s Premere e tenere premuto per 2 secondi	Entra nella modalità associazione		L'indicatore blu lampeggia	Stato di associazione
---	---	-----------------------------------	---	----------------------------	-----------------------

- L'altoparlante StormBox Pro si conetterà automaticamente agli ultimi due dispositivi associati ancora se sono disponibili. Se fallisce, l'altoparlante entrerà nella modalità di associazione.
- Puoi collegare questo altoparlante con più dispositivi e controllare la connessione tramite il pulsante Bluetooth.
- L'altoparlante può memorizzare fino a 8 dispositivi Bluetooth associati.
- Meglio ancora, può connettersi a 2 dispositivi contemporaneamente alla volta.

### 3. Conversione tra 2 dispositivi collegati

- 1) Mette in pausa la riproduzione del dispositivo corrente.
- 2) Riproduci il file audio dell'altro dispositivo.

### 4.Regolazione del Volume

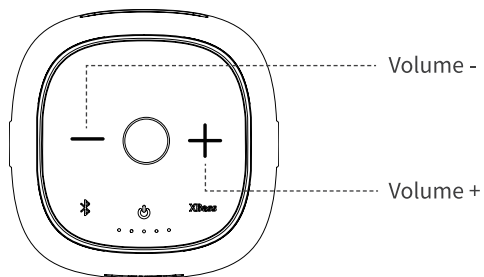

-	Premere brevemente	Diminuire il volume
	Mantenere premuto per alcuni secondi	Diminuire il volume continuamente
+	Premere brevemente	Aumentare il volume
	Mantenere premuto per alcuni secondi	Aumentare continuamente il volume

### 5.Pulsante Multifunzione (MFB)

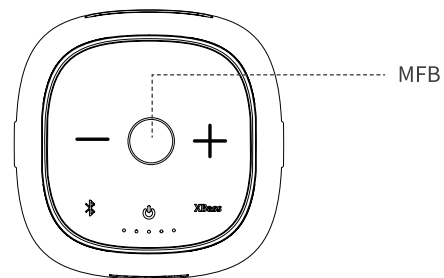

	Modalità Musica	Pressione breve	Avvio/pausa
		Doppia pressione	Prossima Traccia
		Premere per 3 volte	Traccia Precedente
		Premere e tenere premuto per 1 secondo	Attivare Siri
	Modalità Conversazione	Premere brevemente	Rispondere/Chiudere la chiamata
		Premere e tenere premuto per 1 secondo	Rifiutare le chiamate telefoniche
		Premere brevemente	Metti in pausa la chiamata corrente e rispondi alla chiamata in arrivo
		Premere brevemente	Premere insieme due chiamate telefoniche

## 6. Funzione XBass

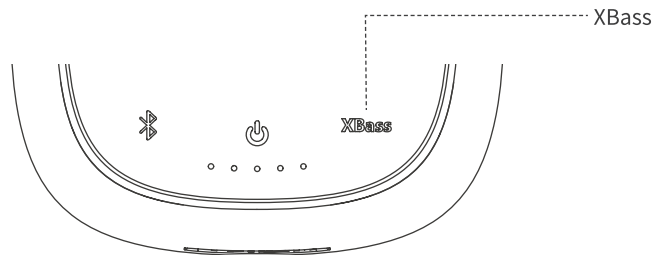

Premere brevemente il pulsante Xbass per attivare la funzione Xbass, l'indicatore Xbass si illuminerà di bianco.

Premere di nuovo brevemente questo pulsante per disattivare la funzione Xbass, l'indicatore XBass si spegnerà.

## 7. Modalità Festa

1) Assicurati che entrambi gli altoparlanti siano accesi.

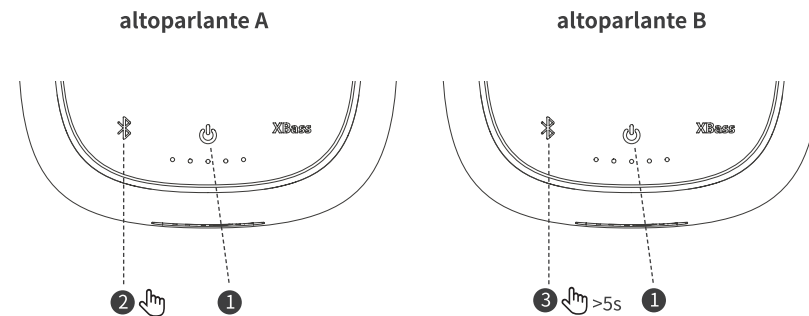

2) Premere e tenere premuto il pulsante Bluetooth di un altoparlante per 5 secondi per accedere allo stato di associazione, quindi tenere premuto il pulsante Bluetooth dell'altro altoparlante per 5 secondi per cercare i dispositivi Bluetooth. In questo momento, sentirai un suono "Modalità party" e gli altoparlanti entreranno in modalità party.

**Annotazioni:** la funzione della modalità party può essere realizzata solo quando si dispone di 2 altoparlanti Tribit Stormbox Pro.



## 8.Modalità Stereo

1) Assicurati che I due altoparlanti siano entrambi nella modalità party.

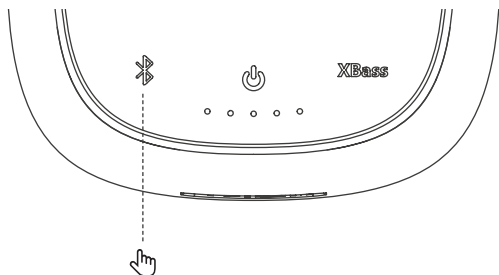

2) Premere brevemente il pulsante Bluetooth su uno dei due altoparlanti.

3) Quando si sente la voce della modalità stereo, un altoparlante suona "Canale sinistro" e l'altro su "Canale destro", si attiva la modalità stereo.

**Annotazioni:** la funzione della modalità stereo può essere realizzata solo quando si dispone di 2 altoparlanti Tribit StormBox Pro.

## 9.Conversione di entrambe le Modalità Party e Stereo

Premere brevemente il pulsante Bluetooth di qualunque dei due altoparlanti.

## 10.10.Disabilitare la Modalità Party e oppure la Modalità Stereo.

Premere e tenere premuto il pulsante per 5 secondi su una qualsiasi delle due casse, quindi entrambi riattiveranno la modalità di associazione Bluetooth.

## 11.Ripristino alle Impostazioni di Fabbrica

Mantenere premuti contemporaneamente i pulsanti Volume + e – per 5 secondi per cancellare l'elenco di accoppiamenti e tutte le impostazioni e l'altoparlante ripristinerà lo stato di fabbrica.

# Specifications

Versione Bluetooth	5.0
Potenza in Uscita	40W
Frequenza	60Hz-20KHz
Tipo Batteria	7.4V/5000mAh Batteria al litio
Tempo di Ricarica	7 hours ore @5V/2A
Dimensioni	96 x 96 x 180 mm
Grado di Impermeabilità	IP67

## パッケージ内容

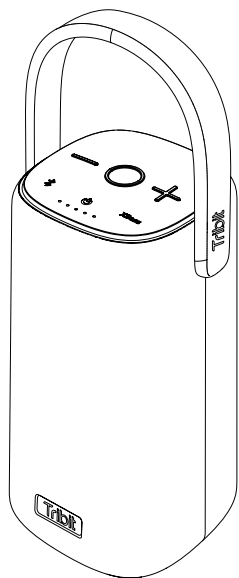

StormBox Pro

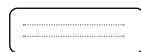

保証カード

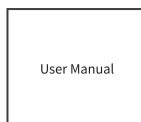

取扱説明書



USB-C ケーブル

## スピーカー各部の説明

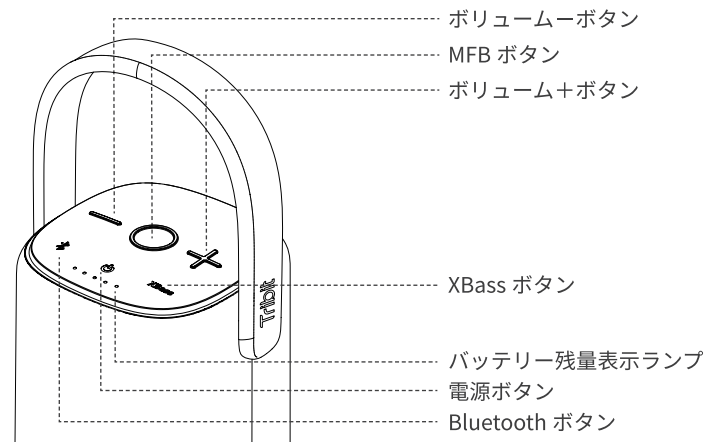

出力ポート

充電ポート

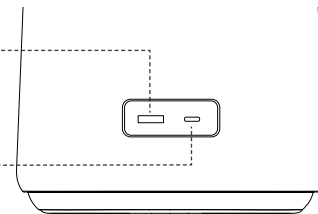

## 充電方法

### 1. スピーカーに充電する

付属した USB-C ケーブルでスピーカーの充電ポートを 5 v の電源コンセントに接続します。

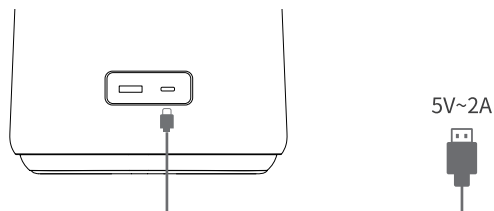

### 2. 他のデバイスを充電する

USB-A 充電ケーブル（別売り）を使用し、スピーカーの出力ポートを USB 充電可能なデバイスに接続します。

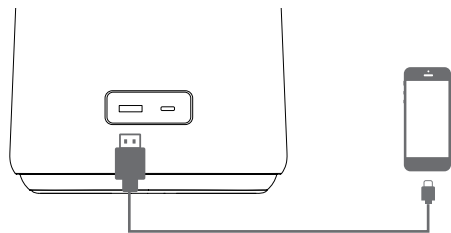

### 3. バッテリー残量ランプ

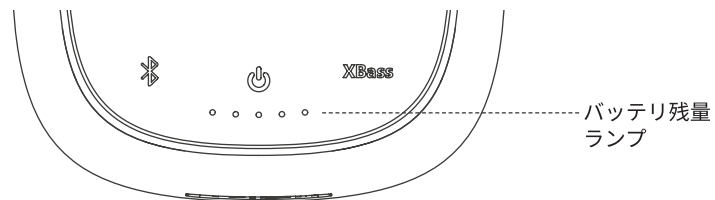

	赤いランプが点滅	電池残量不足
	白いランプが点滅	充電中
	消灯	充電完了



### 4. バッテリー残量の表示

10-30%	30-50%	50-70%	70-80%	80-100%	満充電

# ボタン操作

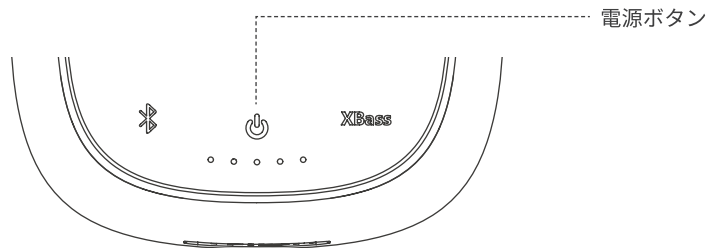

## 1. オン・オフ

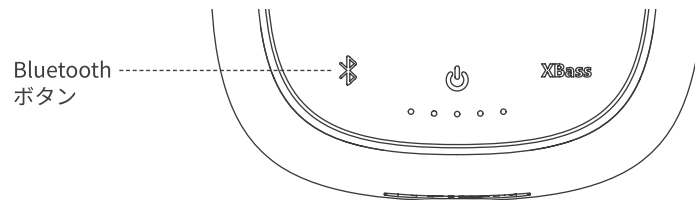

	短押し	電源オン		白いランプが点灯
	短押し	電源オフ		消灯
	10 秒程の長押し	強制終了		消灯

## 2. ペアリング



	2S で長く押し	ペアリングモードに入ります		青色のランプが点滅している	ペアリングしている状態です
---	----------	---------------	---	---------------	---------------

- StormBox Pro の電源に入れると、前ペアリングした最後の 2 つデバイスを自動的に接続します。ペアリング済みの端末がない場合、自動的にペアリングモードに入ります。
- Bluetooth ボタンで複数台のデバイスのペアリングとデバイス間の切り替えが可能です。
- ペアリングしたデバイスを 8 つまで登録可能
- 2 つのデバイスを同時に接続可能。

### 3. ペアリングされた2つのデバイス間の切り替え

- 1) 1つのデバイスを一時停止します。
- 2) もう1つのデバイスを再生します。

### 4. 音量調整

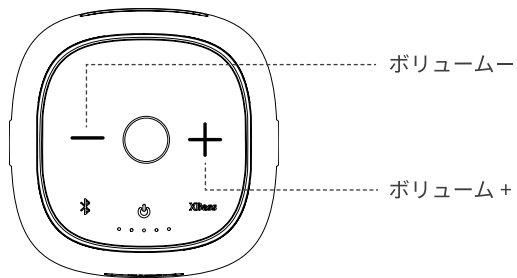

-	短押し	音量を下げます
	長押し	音量を最小まで下げます
+	短押し	音量を上げます
	長押し	音量を最大まで上げます

### 5. MFB ボタン

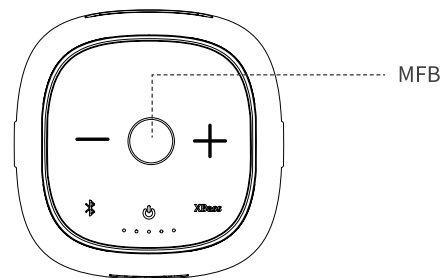

	音楽モード	短押し	再生 / 一時停止
		2回押し	次の曲
		3回押し	前の曲
		1s押し	Siriを呼び出します
	通話モード	短押し	電話を-out / 電話を切ります
		1s押し	着信拒否
		短押し	通話中で他の電話が来た場合、通話を保留すると同時に、他の電話を-out
		短押し	電話を切り替えます

## 6.XBass

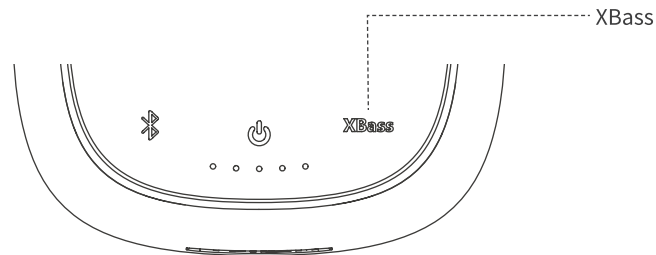

XBass ボタンを短く押し、XBass 機能がオンになります。XBass の標識が光ります。  
もう一度短く押すと、XBass 機能がオフになり、XBass の標識の光が消えます。

## 7. パーティーモード

1) 2 台のスピーカーがオンになっていることを確認してください。

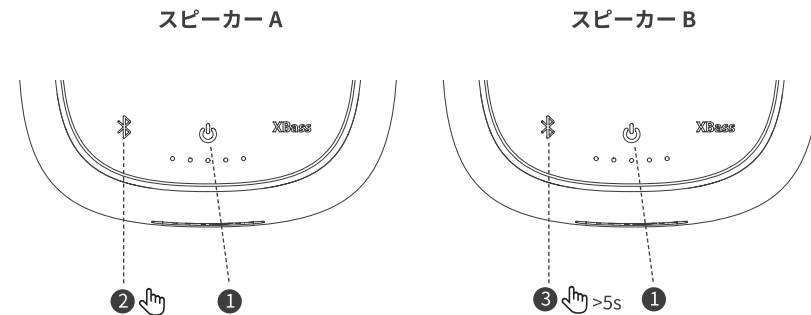

2) スピーカー A の Bluetooth ボタンを 5 秒押し、ペアリングモードに入ります。スピーカー B の Bluetooth ボタンを 5 秒長押し、自動的に Bluetooth デバイスを探します。「Party mode」を聞こえたら、パーティーモードに入ります。

※ この機能は 2 台の Tribit Stormbox Pro スピーカーが必要です。

## 8. ステレオモード

1) 2 台のスピーカーはパーティーモードになっていることを確認してください。

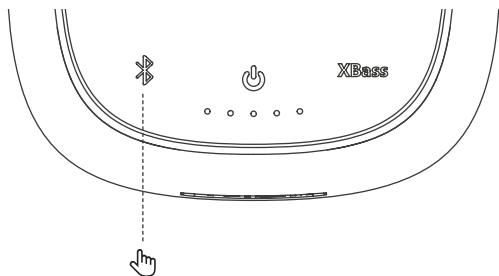

- 2) 任意の 1 台の bluetooth ボタンを短く押してください。
- 3) 「Stereo Mode」を間くと、ボタンから手を離します。1 つのスピーカーが「Left」、もう 1 つのスピーカーが「Right」という音が響いたら、ステレオモードに入りました。

※ この機能は 2 台の Tribit Stormbox Pro スピーカーが必要です。

## 9. パーティーモードとステレオモードの切り替え

任意の 1 台の bluetooth  ボタンを短く押します。

## 10. パーティーモードとステレオモードをオフにする

任意の 1 台の bluetooth  ボタンを 5s で長押し、再びペアリングモードに入り、パーティーモードとステレオモードをオフにします。

## 11. リセット機能

スピーカーが動作しない等の不具合が発生した場合、下記の方法でリセットしてください。「ボリューム+」と「ボリューム-」ボタンを同時に 5 秒ほど長押し、初期化にします。

## 製品仕様

Bluetooth バージョン	5.0
出力パワー	40W
周波数	60Hz-20KHz
バッテリーのタイプ	リチウムイオン電池 7.4V/5000mAh
充電時間	7.0H @ 5V2A
寸法	96 x 96 x 180 mm
防水・防塵規格	IP67